

Kheos PLUS

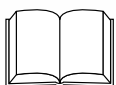

Carefully read this use and maintenance manual before using the unit.

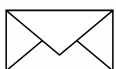

CTR S.R.L. Via T.ed E. Manzini n° 9, 43126 Parma (Italy)
Tel. +39 0521/957611 - Fax. +39 0521/957677
Internet: www.ctr-srl-com E-mail: info@ctr-srl.com

Revision number	1.0	code	330080	Date	08/02/2016
------------------------	------------	-------------	---------------	-------------	-------------------





CTR S.R.L. would like to thank you for buying a product from its range and invites you to read this manual. Inside this manual you will find all the information you need for correctly using the unit; please follow the instructions contained in this manual carefully and read through every section. You should also store the manual carefully to keep it in good readable condition. The content of this manual may be modified without prior notice, nor further obligations, in order to include changes and improvements to the instructions already provided. No part of this manual may be reproduced or translated without prior written consent of the owner. CTR S.R.L. shall be responsible for any manufacturing defect that may arise during the entire warranty period and undertakes to correct any defect as promptly as possible.

WARRANTY

The warranty is valid for 12 months from the date of purchase. The warranty covers only the replacement of faulty parts. The warranty shall be invalidated if the equipment is found to have been improperly used or tampered with by people not authorized by us or if nonconforming components or techniques have been used.

LABELLING

Model Kheos Automatica

 <small>AUTO AIR CONDITIONING PARTS & TOOLS</small>			
CTR S.R.L. via T. ed E. Manzini,9 43126 - PARMA ITALY		MADE IN ITALY	
Model KHEOS AUTOMATICA	Voltage		
Serial N°:	Adsorption A	Absorbed power W	
Max pressure.	Min Temperature.	Max temperature.	
Refrigerant R134a	Year of manufacture	Risk category under 97/23/CE I	

This label is merely indicative. The complete data label is affixed onto the unit.

Declaration of Conformity

Directive EEC 2006/42 – “Machine Directive”

Directive EEC 2014/30 – “Low voltage directive”

Directive EEC 2014/35 – “Electromagnetic compatibility directive”

PED European Directive 97/23/EC

We: CTR S.R.L. Via T. ed E. Manzini n° 9, 43126 Parma (Italy) represented by its Legal Representative, declare on our sole responsibility that the product:

Management System for air-conditioning and cooling systems

Model: Kheos Automatica

complies with the requirements of directive 2006/42/EC, 2014/30/EC and 2014/35/EC and associated implementation provisions; furthermore the pressure circuit complies with directive 97/23/EC as amended, and it is classified respectively:

- category I for the Kheos Automatica model.

We hereby specify that the maximum permissible limits for correct operation of the Kheos Automatica unit are:

- Maximum working pressure: 16 bar
- Maximum working temperature: +50°C
- Minimum working temperature: +5°C

We also point out that:

- the year of manufacture is indicated on the label (with CE marking) affixed onto the unit;
- the technical construction file is kept at our company by the legal representative.

COMPONENTS INCLUDED IN THE PRODUCT

<i>COMPONENT</i>	<i>PED CLASSIFICATION / PROCEDURE OF CONFORMITY EVALUATION</i>
<i>Recovery Compressor</i>	<i>Art.3 par. 3</i>
<i>Cylinder</i>	<i>Cylinder I (D1 module)</i>
<i>Solenoid valves</i>	<i>Art.3 par. 3</i>
<i>Hoses and fittings</i>	<i>Art.3 par.3</i>
<i>Safety valve</i>	<i>IV (B+D modules)</i>



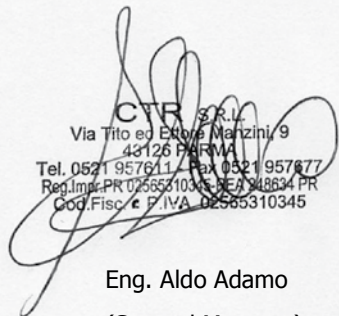

PARMA February 2016

CTR S.R.L.
Via Tito ed Ettore Manzini, 9
43126 PARMA
Tel. 0521 957611 - Fax 0521 957677
Reg.Impr. PR 02585310345 REA 948634 PR
Cod. Fisc. e P.IVA 02585310345
Eng. Aldo Adamo
(General Manager)

POSTCODE	PAGE OF CONTENTS	PAGE
	Declaration of conformity	3
	CE label	4
1	Symbols Introduction	6
1.1	Spare parts	7
1.2	List of functions	7
2	Technical characteristics	8
3	Safety precautions	8
3.1	Work environment	9
3.2	Preliminary checks	9
3.3	Disposal of electrical material	9
3.4	Use	10
3.5	Maintenance	10
3.6	Power supply	11
4	Handling and transport	11
4.1	Mechanical cylinder retainer	12
5	General operating rules	13
5.1	Main panel	13
5.2	Operating phases	13
5.3	Use	14
5.4	"Automatic" operation	15
5.5	"Recovery" operation	16
5.6	"Vacuum" operation	18
5.7	"Charge to vehicle" operation (gas, oil-UV Tracer)	18
5.8	Pipe drainage procedure	20
5.9	Refrigerant topping-up	21
5.10	"Recharge cylinder" operation	21
5.11	A/C system flushing	22
6	"Service" menu	22
6.1	"Operator" service menu	22
6.2	"Technical staff" service menu	23
7	Refrigerant transfer from unit to external container	24
8	Routine Maintenance	25
8.1	Refrigerant filter replacement	25
8.2	Vacuum pump replacement	26
9	Adhesive labels	26
10	SD card database update	27
11	Printer (Optional)	27
12	Troubleshooting	29
13	List of error messages	30
14	Fuses	30

SYMBOLS

The following is a list of the symbols used with a brief explanation.

	DANGER: draws your attention to situations or problems that may cause injury or risk of death.
	WARNING: draws your attention to situations or problems connected with the efficiency of the unit that do not involve a risk to the safety of people.
	PROHIBITION: do not perform the operations indicated as they would affect the level of efficiency of the unit
	IMPORTANT: draws your attention to important information of a general nature that does not compromise personal safety or proper functioning of the unit.

1. Introduction

The unit described in this use and maintenance manual is an automatic multifunctional system with digital setting, with a database for first-installation automotive air conditioning systems and performs the following operations: gas recovery, used oil discharge, vacuum phase, leak test, new oil refill and gas recharge. All these operations are controlled by a microprocessor with electronic precision scales.

Listed below are the main components and their functions:

- Electronic control: controls the entire process by means of a microprocessor.
- 1) Electronic gas weighing scale: can weigh up to 25 kg refrigerant, with 5 g resolution and interrupt the RECOVERY and CHARGE functions if the quantities entered or reached during the operation cannot be handled.
- 2) 12cc refrigerant gas recovery compressor.
- 3) One anti-acid recovery filter and a new-concept dehydrator with reduced environmental impact, featuring low cost and ease of replacement.
- 4) Input gas distiller with automatic flow regulator for separated oil and refrigerant coming from the A/C system with oil discharge.
- 5) Oil separator, located directly behind the compressor, with automatic return during the recovery cycle.
- 6) 12-litre cylinder for refrigerant gas recovery fitted with safety valve.
- 7) Vacuum pump with high vacuum degree.
- 8) Digital control panel.
- 9) Multi-language high-contrast display for use in poor or excessive light conditions.
- 10) 80 mm analogue pressure gauges (Class 1.0) with pulse-free movement for A/C diagnosis.
- 11) Two 2.5 m highly reliable flexible hoses with quick-coupling valves and manual opening (screw fitting) for R134a.
- 12) Two 250 cc beakers with raised graduations for new oil, used oil

	The unit is equipped with 2.5 m hoses for connection with A/C system. If the length of the hoses supplied is not sufficient for your operating and functional needs, please note that 3 and 6 m hoses are available from our point of sale.
---	--

	The unit is supplied with two containers for feeding oil and UV tracer and one for oil discharge. If you need to use different types of oil, you will need to keep a different container for each type of oil.
---	--

	Make absolutely sure that different kinds of lubricants are not mixed together. Always check what type of oil you need to use in the various A/C systems (depending on compressor type used); oil types can be identified by means of specific technical data sheet.
---	--

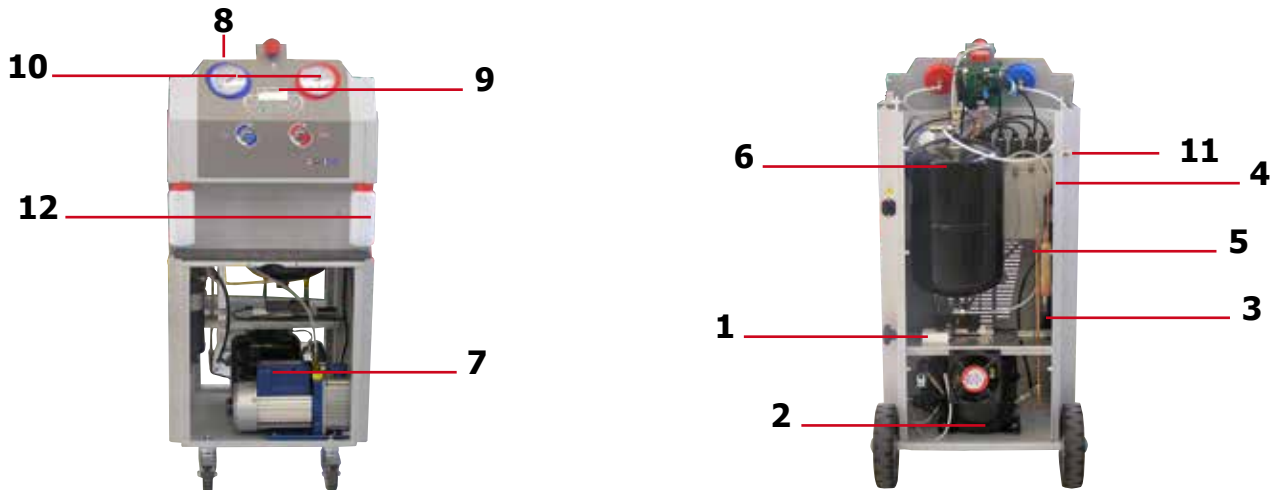

1.1 Spare parts

All Kheos Plus spare parts are sold by CTR S.R.L. and can be requested from our points of sale.

Spare parts must be installed by your local dealer's specialized technicians.

1.2 List of functions

- **Recovery:** allows the unit to recover both the refrigerant and part of the oil mixed in it, automatically separating and storing them. The polluted oil is recovered in an external graduated container. After regeneration through the filters, the refrigerant is stored in a dedicated cylinder. Quantification is performed automatically by the system's scale.
- **Vacuum:** the A/C system can be brought to the maximum vacuum level within the preset time and kept in this condition. This makes it possible to completely evacuate moisture and check vacuum seal for possible leaks.
- **Recharge to vehicle:** the regenerated refrigerant can be recycled (after adding new oil if needed) using the methods indicated by the operator. You can also add the desired quantity of new refrigerant fluid, new oil and UV tracer.
- **Recharge cylinder:** this function is used to fill the internal cylinder and is controlled by an electronic process.
- **Automatic cycle:** performs the sequence of all the operations required to restore the system to the correct levels of refrigerant and oil without operator intervention.

	Do not use the unit for purposes other than those for which it was designed. When scrapping the machine, you must comply with current regulations in force locally (bear in mind that the unit contains refrigerant fluids; use the services of specialized firms).
	The unit is supplied with the type of refrigerant indicated in the CE label. Do not refrigerants other than the one indicated.
	The Nordik unit is designed to perform the operations of recovery, vacuum and charge of R134a refrigerant contained in automotive air conditioning systems.
	The Nordik unit must not be used to transfer fluids and/or recharge other liquids. Do not fluids other than R134a, in particular use with flammable liquids is prohibited.
	In case of improper use of the station with resulting contamination of the R134s refrigerant and/or of the vacuum pump oil (e.g. recovery of gas other than R134a, vacuum on circuits containing oils other than the vacuum pump oil), switch the unit off immediately and contact our technical service department.
	Before using the unit, operators must be suitably trained and assisted by technical staff trained by our company.
	Operator: person trained to use the machine (trained directly/indirectly by CTR staff) Specialized technician: person trained and authorized by CTR to perform technical procedures.

2. Technical characteristics

The technical specifications shown below refer to the specific models.

Description	Unit of measure	Nordik
Max absorbed power	W	900
Net weight	Kg	60
Overall dimensions (HxWXD)	cm	104X48X58
Weight (fully charged)	kg	75
Vacuum pump flow rate	l/min	100
Final vacuum	mbar	0.1
System recovery capacity	g/min	400
Refrigerant cylinder capacity	l	12
Power supply voltage	V	220/240
Power supply frequency	Hz	50
Max absorbed current	A	4
Vehicle coupling diameter (LP – Low pressure)	mm	11
Vehicle coupling diameter (HP – High pressure)	mm	16
Max operating temperature	°C	50
Min operating temperature	°C	5
Maximum pneumatic circuit pressure	bar	16

For the connection voltage value, instructions are provided on the label on the unit.

The sound pressure value measured is less than 70 dBA therefore the operator does not need to take any particular protection measure even in case of continuous use (ISO 3746). Nonetheless, the employer is responsible for evaluating the level of noise the workers are exposed to in accordance with workplace hygiene and safety regulations currently in force.

3. Safety precautions

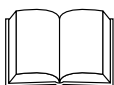

We recommend you read through every section of this use and maintenance manual carefully before proceeding and to make yourself familiar with the unit's controls.



In case of need, contact only our Technical Service Department (in particular for components repair and replacement).



Do not perform any repair operations. Repair operations performed by inexperienced staff may affect the safety level of the unit.



Do not place any objects on the unit; the unit must not be used as a support surface or means of transport.



Connection hoses (A/C system) and feed hoses should be positioned in a way that will not cause hindrance and prevent them from being damaged.



For refrigerant recovery do not use (pressurized) containers that are unfit for the purpose, in terms of material type and pressure level.



Current workplace hygiene and safety regulations must be observed at all times. Always refer to the safety data sheet and comply with its instructions. Never leave the unit unattended in the workplace, even in case of automatic operation.

3.1 Work environment



Only responsible adults must be allowed to use the unit. Make sure that the control device is not used by children.



Do not move close to the unit with naked flames or anything else that might cause overheating of the refilling circuit (with consequent fire hazard). Do not use the unit in places where there is a risk of explosion or fire.



Do not smoke in the area where the work phases are performed.



Operate the unit in places with adequate lighting.



Make sure that there is adequate ventilation. Operate and store the unit in a dry place, protected from the weather (in general avoid harsh environmental conditions).

For correct use of the unit, read through the essential safety rules for the operator contained in this manual: Wear safety gloves and goggles. Do not expose to rain or direct sunlight. Before you use the unit, read the car's operation and maintenance manual to identify the type of refrigerant.



3.2 Preliminary checks



If the unit is switched off due to a power failure, wait about 10 seconds before restarting it, so that the electronic part can reset the unit correctly.

The electrical/electronic material must be disposed of separately in accordance with current regulations.

3.3 Disposal of electrical material



When disposing the unit, you must:

1. separate the unit's parts by type (e.g. plastic, dangerous liquids, metal, etc.) in particular, any waste from electrical/electronic parts must not be disposed of as urban waste but is to be collected separately;
2. disposal must be through public or private collection systems as required by local regulations;
3. this unit may contain dangerous substances: improper use or incorrect disposal could have negative effects on human health and on the environment;

3.4 USE



Take special care with possible ejections of refrigerant because:

- contact with eyes may cause serious injury;
- contact with the skin (given the extremely low boiling temperature) may cause burns.

If refrigerant is splashed into your eyes or onto your skin, rinse with plenty of water and immediately seek medical assistance.



The unit has been designed for specific use with refrigerant R134a.
The type of refrigerant (R134-a) to be used is indicated on a specific label.



After switching the unit on, allow at least five minutes before performing any operation. If the work cycle is interrupted for whatever reason (e.g. power failure), the operation must be restarted from the beginning.



In case of emergency press the red push button in the panel to remove power completely



The external container used for refilling must be type approved for pressure levels of at least 35 bars and equipped with a safety valve (the valve must comply with the regulations for pressurized containers).



The refrigerant storage container must NEVER be filled to over 80% its total capacity to prevent drops in efficiency. During operation, check fill level of oil containers and ensure they are not overfilled to prevent sudden drops in efficiency. Do not use these containers with different types of materials.

Live parts



EMERGENCY PUSH BUTTON



POWER SOCKET



The unit is designed for use by a single operator. Other persons should keep at a safe distance during operation as well as during adjustment and maintenance.



Always connect the high and low pressure ducts (red and blue) with the parts supplied and do not use them for purposes other than those specified.



During operation, check the level in the oil tanks to prevent overflowing .



You must NEVER disconnect the HP and LP hoses, unless specifically requested in this manual. Do not open the manual valves during normal operation unless expressly requested in the instructions.

3.5 Maintenance



Do not, under any circumstance, use flammable liquids or detergents to clean the unit. Use only neutral detergents; failure to do so will invalidate the warranty for damaged parts.



Always allow a few minutes after switch off to enable the system to return to its rest condition (temperature and pressure).



During maintenance procedures, do not discard any residues into the environment, but comply with current disposal regulations.



The cylinder must NEVER be removed unless specifically indicated.

Do not perform any repair or maintenance operations when the unit is running or connected to the mains.



The only maintenance and repair procedures to be performed are the ones indicated in this manual. Operations performed by inexperienced staff will affect the overall safety level of the unit and expose the operator to serious risks.

3.6 Power supply

The power supply of the unit must be connected in accordance with the instructions of CTR S.R.L.. However, the company will not be responsible for the connection. The safety of the unit is ensured only when it is correctly connected to a power source that has all the protection features required by current applicable regulations (differential safety switch and earth).

- The connection to the mains must be made using the plug provided with the unit, and a reduction used if necessary; you must first check that the line voltage corresponds to the one indicated on the label on the rear of the unit.
- In the event of damage, you must contact our Technical Service Department.



If the power plug needs to be replaced, contact our Technical Service Department; do not replace the plug unless you have first obtained written permission by our competent department. Failure to comply with the above requirement will relieve CTR S.R.L. of any responsibility for personal injuries or property damage caused by the power supply.



If using extensions, check that the section of the cable is adequate for its length and that it is positioned so as to prevent every kind of damage (avoid walking areas and wet areas).



Make sure that the point of connection to the power source has all the protection features required by the applicable regulations (earth and differential switch).

4. Handling and transport



Before moving the unit, check that it is stable (check that the support surface is horizontal).

Before moving the unit, we recommend you remove the parts installed after delivery in order to prevent damage.



During this phase, you should:

- correctly position all the accessories provided to prevent them from falling or being damaged during transport;
- move slowly and carefully to prevent possible instability;
- keep at a safe distance.



Be especially careful when handling the unit in the workplace. In particular, avoid humps, steps or similar. Lack of care during transport may affect calibration of the unit.

	 PROHIBITED	
		
<p>To transport the unit, use the wheels on the base and push the unit along. Move unit on flat surfaces only. For long distances or uneven floors, apply the mechanical retainer on the cylinder.</p>	<p>To handle the unit, all the wheels must touch the ground to ensure the unit remains level.</p>	<p>To lift the unit, use a lift truck with adequate capacity (see technical specifications for unit's weight). Use the pallet as support base.</p>



4.1 Mechanical cylinder retainer

The mechanical retainer is designed to prevent involuntary movements of the refrigerant's scale.

- Press all the way down to block the cylinder (figure 1)
- Pull all the way to release the retainer. Do not rotate (figure 2)

This high-precision mechanical system retains the cylinder lifting its weight of the scale.

When this mechanism is in place, the electronics will prevent all operations and display the message "Remove block". Remove block and press ESC for 2 seconds. Accidental application of the retainer during operation, will be indicated by the message "Remove block" and immediate stopping of the operation under way.

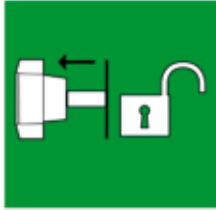
B L O C K E D			U N B L O C K E D
			

5. General operating rules

5.1 Main panel

The following is a description of the unit's control panel:

Description

1	I/O Main/emergency switch	9	HP (high pressure) valve
2	Control panel	10	New Oil filling tank
3	Esc button	11	Used oil discharge tank
4	OK/Enter button	12	High pressure connection
5	Forward/back/plus/minus buttons	13	Low pressure connection
6	High pressure gauge (30 bar)	14	Refrigerant filters
7	Low pressure gauge (15 bar)	15	Printer (Optional)
8	LP (low pressure) valve		



5.2 Operating phases.

Described below are all the steps that the operator must follow to obtain optimal results in perfectly safe conditions, distinguishing between manual and automatic operation. To check that the unit is operating correctly, an intelligent control device has been provided to signal faults and warn the operator by means of error messages. An acoustic warning at the beginning of an operation indicates that the function entered has started in the correct condition, and a second acoustic warning indicates when the operation has been completed. Before performing the operations described below, to improve system efficiency (in terms of energy and time) start the vehicle's engine and let the cooling system run for a few minutes so that the A/C system can reach full power, i.e. normal operating conditions.



If you have any questions or doubts regarding the unit's operation, please do not hesitate to contact our Technical Service Dept. or Authorized Dealer.



During refilling operations, some of the refrigerant will be left in the connection pipes. To drain the pipes, follow the instructions provided in the chapter "Pipe draining procedure" (par. 5.8).



At the end of the various phases there will be different residues in the containers. Disposal of these residues must comply with current regulations.



The recovery, vacuum and charging operations must be carried out with the vehicle and system off (with compressor power disconnected).

5.3 Use

We advise you to carefully read through this manual for proper use of the unit.

Activation/deactivation:

- Connect the cable to the mains as described in the chapter "Electric power supply".
- Enable the red mushroom button positioned on the control panel by turning it slightly to the right.
- Hold the red ESC button pressed down for 2 seconds to turn the unit on and off. To cut the power to the unit, press the mushroom button and cut the power to the disconnection switch (electrical socket of the unit).
- **If the printer light is on and the rear electric fan is working, it means that the unit is powered.**



Display messages:

When the unit is switched on, for a few seconds the display will be as shown in figure 1.

FW indicates the software version of the unit.

DB indicates the database version. Each time the SD card is updated, the version number changes automatically.

Fig. 2 shows the main menu listing the functions and the total quantity of gas in the cylinder.

Fig. 3, below the broken line, shows the data of the unit's sensors during any function. Above the broken line, you have data, times and messages for the current operation (e.g. recovery).

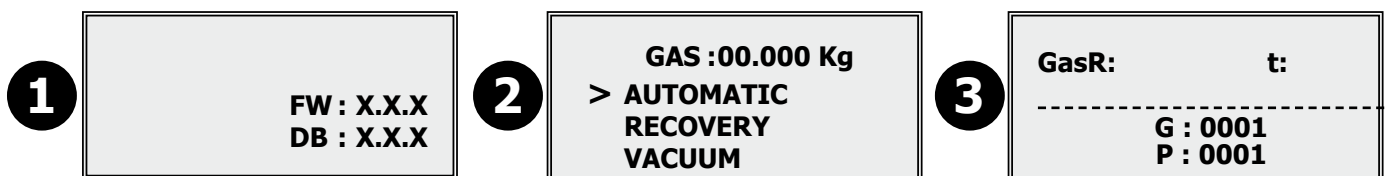

5.4 “Automatic” operation

With this function, the system performs the cycle consisting of: recovery, recovered oil discharge, vacuum phase, leak test and refrigerant charge, to restore the car’s A/C system with the necessary quantities of fluids, using the database present in the unit’s SD Card memory, or with the values entered by the operator. Oil filling charge is automatic and is to be carried out before the refrigerant charge.

The automatic cycle can be performed in two ways:

- 1- Database controlled automatic cycle.
- 2- Operator controlled automatic cycle.

The database controlled semi-automatic cycle allows the unit to perform all the operations using the first-installation information contained in the memory card.

The operator controlled semi-automatic cycle makes it possible to perform all the operations with the refrigerant values and vacuum time values selected by the operator.

TO EXECUTE THE DATABASE CONTROLLED CYCLE

- Connect the high and low pressure pipes to the A/C system
- Open the HP and LP valves, or if there is only one service point, open the corresponding valve.
- Select “AUTOMATIC” with the “+ ↑” and “- ↓” buttons. Press OK to start the cycle.

Move in the database using the up “+ ↑” and down “- ↓” arrows to select the required model and press the OK button. To go back, press the ESC button for 2 seconds.

- Select the brand (Fig.1), select the model (Fig.2), select the equipment (Fig.3), view the quantity of fluids and oil viscosity (Fig.4), then press OK to confirm. Move the cursor “>” (fig.5) to the items involved “Gas”-“Oil”-“Vac”, press OK button to select it and use the “+ ↑” and “- ↓” buttons to edit the value. Changes are made in 5 grams steps for gas quantity, in 1 gram steps for new oil quantity and in 5 minutes steps for vacuum time.

- Select “Start cycle” and press OK button to continue.

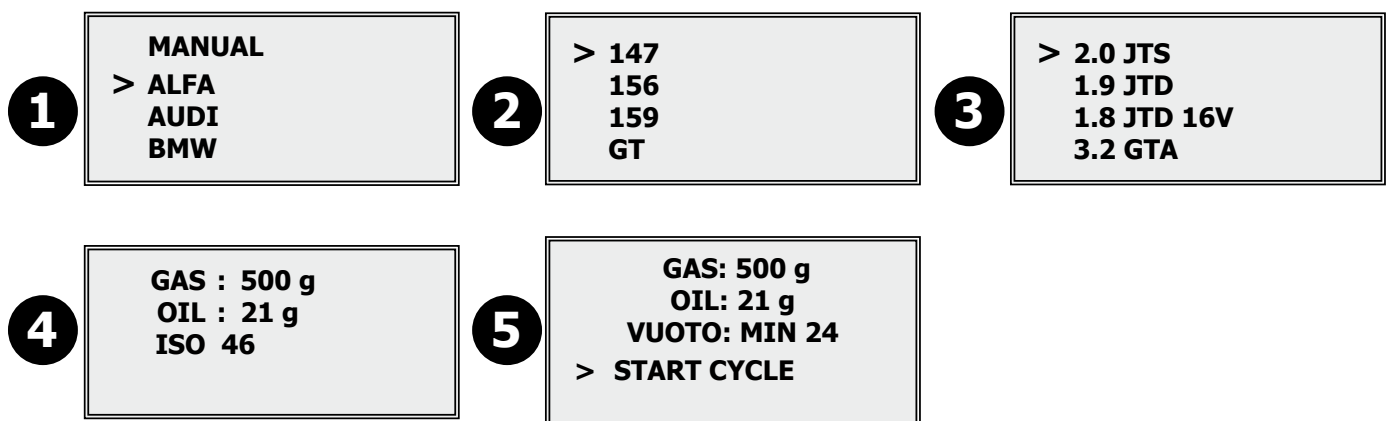

- Once the cycle has been started, if conditions permit, the system performs the cycle and displays all the current phases with values and text messages. The refill unit automatically performs the gas Recovery, the recovered Exhaust Oil discharge, the Vacuum, the Leak test, the New Oil refilling and the Gas charge.

- If an error occurs, the display will show the associated message and give an acoustic signal. To exit, press ESC for 2 sec.
- During operation, press ESC button for 2 seconds to exit.
- Once the cycle has been finished, press ESC button for 2 seconds to return to the main menu.

(-When you exit the operation, you will be prompted to print the report, if this feature is present. Press OK to print or ESC to return to the main menu.)

EXECUTING THE OPERATOR-CONTROLLED CYCLE

- Connect the high and low pressure pipes to the A/C system
- Open the HP and LP valves, or if there is only one service point, open the corresponding valve.
- Select "AUTOMATIC" with the "+ ↑" and "- ↓" buttons. Press OK to start the cycle (Fig.1)

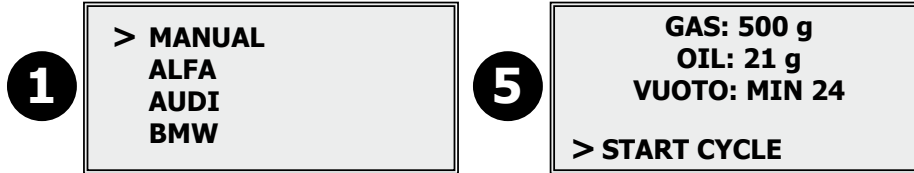

- When the "Manual" mode is selected, the system will directly suggest a fixed quantity of gas, which is 500 g (default Customizing in Service menu), and the grams of oil calculated on the quantity of refrigerant set. You can also change the values suggested for gas, new oil and vacuum (fig.5), using the "customizing" function in the SERVICE menu.
- Move the cursor ">" to "Start cycle" and press OK to start the operation. Once the cycle has been started, if conditions permit, the system performs the cycle and displays all the current phases with values and text messages.

Changing gas quantity, new oil quantity and vacuum time

To change a quantity, move the cursor ">" to the item involved (Fig.5), press OK to select it and use the "+ ↑" and "- ↓" buttons to change the value. Changes are made in 5 g steps for gas, in 1 gram steps for new oil and in 5 minutes steps for vacuum. To disable an item, set the value to zero.

5.5 "RECOVERY" operation

"RECOVERY" operation

With this function, the system draws all of the refrigerant from the system and makes it reusable by means of a complete filtering and distillation process.

The RECOVERY cycle can be performed in two ways:

- 1 - Total recovery "AUTO" cycle
- 2 - Partial recovery cycle "g to recover"

Executing total recovery "AUTO" cycle

- Connect the high and low pressure pipes to the A/C system
- Open the HP and LP valves, or if there is only one service point, open the corresponding valve.
- Select RECOVERY with the "+ ↑" and "- ↓" buttons.

Press "OK" to enter the "AUTO" cycle and recover refrigerant until there is no pressure. To start the recovery cycle press OK. During this operation, the display shows the general parameters, and "GasR:" indicates the gas recovered and the time taken. There is a pause in the recovery phase when atmospheric pressure is reached. (value controlled by the pressure sensor).

- This period lasts about 4 min , including old oil discharge, in order to allow any refrigerant that has remained blocked in the low pressure and temperature A/C system to expand for recovery. This phase is indicated by an increase in pressure shown on the

display under "P:" (pressure read by the sensor). After the pause, if the pressure has increased, the system repeats the function a maximum of three times, while when there is no pressure it ends the cycle.

- During operation, press ESC for 2 sec. to exit the phase and return to the main menu. In this case you will not be prompted to print the report (if printer is present).
- Once the cycle has been completed, press ESC for 2 sec. to exit.
- When you exit the operation, you will be prompted to print the report, if the printer is present. Press OK to print or ESC to return to the main menu.
- All the refrigerant recovered in this operation increments a recovery counter to monitor the life of the filter; when a total of 45 kg has been reached, a message will appear on the display informing you that the filters need to be replaced. The counter increases in 5 g steps.
- If an error occurs, the display will show the associated message and give an acoustic signal. To exit, press ESC
- The time available for the operation is 30 min.



The used oil container must always be empty to prevent leaks.

Executing the partial recovery cycle "g to recover"

This function is used to recover a quantity of refrigerant between 10 g and 1000 g in the gaseous state and to quantify it accurately.

If the quantity of refrigerant is excessive, low pressure can be used to draw and weight the actual grams (+5g) of refrigerant removed from the car and fed into the cylinder, without any residues in the unit.

- Connect the low pressure pipe to the A/C system
- Open the LP valve.
- Select RECOVERY with the "+ ↑" and "- ↓" buttons.

Press "OK", the display will read "AUTO"; use the "+ ↑" and "- ↓" buttons to select only the grams to be recovered. To start the recovery cycle press OK. During this operation, the display shows the general parameters, and "GasR:" indicates the gas recovered and the time taken. The recovery phase ends when the amount of "g" entered is reached.

This cycle does not include a used oil discharge phase.

- During operation, press ESC for 2 sec. to exit the phase and return to the main menu. In this case you will not be prompted to print the report (if printer is present).
- Once the cycle has been completed, press ESC for 2 sec. to exit.
- When you exit the operation, you will be prompted to print the report, if the printer is present. Press OK to print or ESC to return to the main menu.
- All the refrigerant recovered in this operation increments a recovery counter to monitor the life of the filter; when a total of 45 kg The counter increases in 5 g steps.
- If an error occurs, the display will show the associated message and give an acoustic signal. To exit, press ESC
- The time available for the operation is 30 min



The used oil container must always be empty to prevent leaks.

5.6 "VACUUM" operation

With this function, the moisture in the system is evaporated by means of a pump that generates a high degree of vacuum.

- Connect the high and low pressure pipes to the A/C system.
- Open the HP and LP valves, or if there is only one service point, open the corresponding valve.
- Select VACUUM with the "+ ↑" and "- ↓" buttons.
- Press OK to start the cycle. The display will show the vacuum time, currently set at 30 min.
Use the "+ ↑" and "- ↓" buttons to change the value to between 05 and 95 min. You can also change the values suggested for vacuum time, using the "customizing" function in the SERVICE menu.
- Press "OK" to continue with this function. Before starting the vacuum, the unit runs a check of the starting conditions with the "vacuum preparation" phase, the microprocessor briefly opens the solenoid valves, and based on the conditions acquired, it will decide how to proceed. Various combinations may be applied, including activation of recovery and oil discharge; also simultaneously with the vacuum.
- When the vacuum pump has started, the message changes to "Waiting for pressure level" waiting to reach the vacuum pressure (-0.75 bar) to count down the preset time. When the level has been reached, the "Vacuum cycle" starts followed by the remaining time.
- During operation, press ESC for 2 seconds to return to the main menu.
- In the event of an emergency, press the red push button on the control panel to completely turn off the unit; in this case, the function that was in progress will not be saved.
- When the set time has elapsed out, a leak test is run for 5 min., and the progress bar shows the remaining time. If a leak is detected (-0.75 bar) the "System leak" error message is shown on the display followed by an acoustic signal.
- When the cycle has been completed, the display read "db"; difference expressed in mBar of the vacuum lost during the leak test. To exit, press ESC for 2 seconds.
- When you exit the operation, you will be prompted to print the report, if the printer is present. Press OK to print or ESC to return to the main menu.
- The operation time of the vacuum pump increments a vacuum hour counter used to control oil replacement.
After 100 h of operation the display will inform you that replacement is required. The counter increments in sec. steps.
- *If an error occurs, the display will show the associated message and give an acoustic signal. To exit, press ESC for 2 sec.*

5.7 "CAR CHARGING" operation

This function is designed to charge the system with the correct quantity of refrigerant and new oil.



Make absolutely sure that different kinds of lubricants are not mixed together. Always check what type of oil you need to use in the various A/C systems (depending on compressor type used); oil types can be identified by means of specific technical data sheet.

Refrigerant charge is performed at medium pressure to prevent damage to A/C system components caused by the transfer of refrigerant at excessive pressure. With high pressure in the cylinder, charging takes place at intervals regulated by the difference in pressure between the vehicle and the unit.

If the outdoor temperature is low, before proceeding with the charge to vehicle phase, use the function "Cylinder pressure > 7 bar" described in the "**SERVICE**" menu section.

- Connect the high and low pressure pipes to the A/C system
- Open the HP and LP valves, or if there is only one service point, open the corresponding valve.
- Select "CAR CHARGING" with the "+ ↑" and "- ↓" buttons and press OK to confirm. (Fig.1)
- Select the brand, select the model, select the equipment, view the quantity of fluids and oil viscosity, then press OK to confirm.
- Move the cursor ">" to the items involved "Gas"- "Oil"- "Vac", press OK button to select it and use the "+ ↑" and "- ↓" buttons to edit the value. Changes are made in 5 grams steps for gas quantity, in 1 gram steps for new oil quantity and in 5 minutes steps for vacuum time.
- Select "Start cycle" and press OK button to continue.

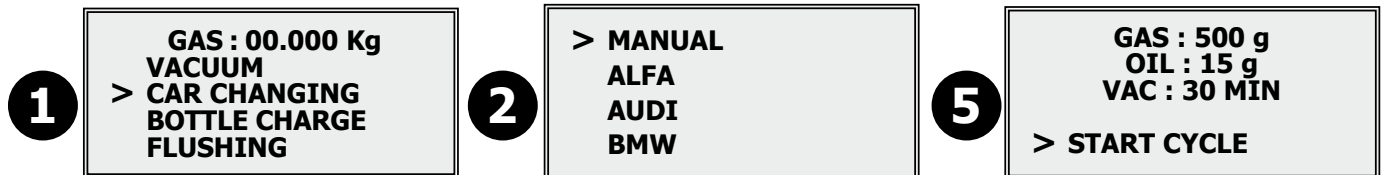

- Once you have selected "CAR CHARGING", you can select to continue in two ways (Fig.2):

- 1 - Database controlled charge
- 2 - Manual charge

- **Database** controlled charge allows you to use the first-installation values for gas, oil-type and recharge quantity given by the memory card after selecting the vehicle.

- Select "Start cycle" and press "OK" button to continue.

The refill unit beeps and display shows the message "Oil: XXXXg". It means that, if necessary, it's possible to refill the A/C car system with new Oil; the new Oil quantity is shown by the display and it's the same value view during the car selection.

- Press and hold on "OK" button to refill the new Oil and check the level in the new oil bottle (OIL IN).
- Release "OK" button when the correct amount of new oil has been filled.
- Press "ESC" button for the next step.

The refill unit beeps again.

- Press "OK" button to continue.

The refill unit automatically continues with the gas charge process.

If an error occurs, the display will show the associated message and give an acoustic signal. Press the "ESC" button for 2 seconds to exit

At the end of the cycle, you will be prompted to print the report, if this feature is present.

- Press "OK" button to print or "ESC" button to return to the main menu.

- **Manual** filling enables you to set the refrigerant value you require. The 500g value given as default can be changed using the "+ ↑" and "- ↓" buttons (fig.5), or you can enter a new value through the "Service-Customizing" menu.

The quantity of oil displayed is the result of the proportion of the gas and oil mix, so that you will know the exact quantity of oil that needs to be charged into the A/C system for the refrigerant alone.

- To disable an item, set the value to zero.



Caution: to fill the system with oil and UV tracer, it must be in vacuum mode, otherwise filling will not be performed. When the vacuum is low, the cycle may be started but then it will be locked when the pressure difference levels out.

- Select "Manual" and press "OK" button to confirm.

The refill unit will directly suggest a fixed quantity of gas (500g), and the grams of oil calculated on the quantity of refrigerant gas set. To change the gas quantity and the new oil quantity, move the cursor ">" to the items involved "Gas"- "Oil", press "OK" button to select it and use the "+ ↑" and "- ↓" buttons to edit the value. Changes are made in 5 grams steps for gas quantity and 1 gram steps for the new oil.

- Select "Start cycle" and press "OK" button to continue.

The refill unit beeps and display shows the message "Oil: XXXXg". It means that, if necessary, it's possible to refill the A/C car system with new Oil; the new Oil quantity is shown by the display and it's the same value view during the car selection.

- Press and hold on "OK" button to refill the new Oil and check the level in the new oil bottle (OIL IN).

- Release "OK" button when the correct amount of new oil has been filled.

- Press "ESC" button for the next step.

The refill unit beeps again.

- Press "OK" button to continue.

The refill unit automatically continues with the gas charge process.

If an error occurs, the display will show the associated message and give an acoustic signal. Press the "ESC" button for 2 seconds to exit

At the end of the cycle, you will be prompted to print the report, if this feature is present.

- Press "OK" button to print or "ESC" button to return to the main menu.

Changing gas quantity, new oil quantity and vacuum time

To change a quantity, move the cursor ">" to the item involved (Fig.5), press OK to select it and use the "+ ↑" and "- ↓" buttons to change the value. Changes are made in 5 g steps for gas, in 1 gram steps for new oil and in 5 minutes steps for vacuum. To disable an item, set the value to zero.



Use only PAG or ESTER oils for lubrication of automotive A/C systems containing R134a refrigerant.



In the event of improper use of the unit, with consequent oil contamination, switch the unit off immediately and contact our Technical Service Dept.



Do not use solvent based additives.
 Do not use sealing liquids

- Oil must be charged as described in the 5.7 operation, through which they will be drawn up due to the vacuum formed, before pressing the OK button for gas charge.

Avoid pulling out the containers as much as possible to reduce the entry of humid air from the outside.

5.8 Pipe draining procedure

1. When the procedure has been completed, keep the high and low pressure pipes connected, close the HP and LP valves, start the vehicle's engine and wait a few minutes for the A/C system to reach full power.

2.If there is only one service point, close the HP or LP valve used and disconnect the pipe from the vehicle.

3. If there are two service points, disconnect the high pressure pipe (HP) from the vehicle and open the HP and LP valves to allow the gas contained in the pipes to return through the low pressure in the vehicle. Wait until the high and low pressures drop to a value of about 2 bar, then also disconnect the low pressure pipe (LP).

4. Stop the engine.



This phase must be performed with the engine on. The other phases strictly with the engine off.

5.9 Refrigerant topping-up

If there is refrigerant in the A/C system, the only way to fill the system with more gas is to perform a TOP-UP operation. To perform this phase, connect the unit to the A/C system, start the vehicle's engine and wait a few minutes for the A/C system to reach full power.

- Connect the low pressure pipe.
- Start the engine and the A/C system
- Partially open the low pressure valve (LP)
- Select the "FILLING" operation and press OK to start the cycle.
- Select "GAS" , set the desired quantity and then press OK.
- Select "START CYCLE" and press OK.
- When charging has been completed, close the LP valve, stop the A/C system and the engine.



This phase must be performed with the engine on. The other phases strictly with the engine off.

5.10 "BOTTLE CHARGE" operation

This function is used to fill the internal cylinder with refrigerant. Filling is set to 7 kg on a total of 10 to ensure there is always a good charge level and sufficient volume to perform the recovery operations.

Use the red high pressure **HP** pipe; connect the pipe to an external cylinder containing refrigerant. **If the external cylinder is not equipped with an internal plunger, it must be turned upside down so that the gas can always flow out in the liquid state.**

- Open the cylinder and HP valve.
- Select " Recharge cylinder" using the "+" and "-" buttons. Press OK to start the cycle.
- The display shows "Estimated charge:" quantity of refrigerant (in grams) required to completely fill the cylinder with 200g approximation. You can also change the maximum filling value as desired using the "Customizing" function in the SERVICE men, or reduce the estimated value with the " ↓ " button.
- Press "OK" to continue with this function. During this operation, the display shows the general parameters, and "GasR:" indicates the gas recovered and the time taken. The unit adapts its recovery capacity in relation to the pressure coming from



the external cylinder. Just before reaching the estimated value, operation is locked, the acoustic signal is activated and the message "Close cylinder and press OK" appears on the display in order to arrive at the calculated value without pressure residues in the unit.

- During operation, press ESC for 2 sec. to return to the main menu.
- In case of emergency press the red push button in the panel to switch off the unit completely; in this case the function that was in progress will not be saved.
- Once the cycle has been completed, press ESC for 2 sec. to exit.
- This cycle does not increment the filter counter.
- *If an error occurs, the display will show the associated message and give an acoustic signal. To exit, press ESC. This operation increments the "GASRB" counter in the "SERVICE" menu.*

5.11 A/C SYSTEM FLUSHING

This function is designed to remove oil and residues that may be carried over by the refrigerant R134a.

Connect the external flushing KIT (available for purchase at our sale outlets).

	Do not flush the A/C system without first connecting the external flushing kit.
	Conditions for starting the operation: Min. 4 kg refrigerant in the cylinder and no pressure in the vehicle.

Press "OK" to start the cycle. The filter life counter included in the external flushing kit used for this function appears. To clear the counter press the "OK" and "-" buttons simultaneously. Press OK to continue and choose whether to perform the kg-based flushing (from Min 5kg to Max 10kg refrigerant flushed into the A/C circuit) or the automatic function by simply choosing the vehicle from the database.

Press OK to start the process, which includes refrigerant charge and discharge cycles followed by recovered oil discharge cycles.

Once the cycle has been completed, press ESC for 2 sec. to exit.

When you exit the operation, you will be prompted to print the report, if the printer is present. Press OK to print or ESC to return to the main menu.

6. "SERVICE" menu

6.1 "Operator" service menu



Operator: person trained to use the machine (trained directly/indirectly by CTR staff)



The basic settings enable immediate operation of the unit in every phase.

- This menu includes all the functions needed to use and customize the unit to best suit your needs.

Use the "+ ↑" and "- ↓" buttons to select "SERVICE" in the main menu, then press "OK".

- **"Pressure in cylinder >7 Bar"**. This function is used to increase cylinder pressure through a combination of operations. Close

the HP and LP valves, then press "OK" to start the cycle. The letter P. displays cylinder pressure during cycle. When pressure exceeds 7 Bar, the cycle stops.

- **"View parameters"**. By accessing this option, all the current values of the unit sensors are displayed with the relative symbols: G: Kg gas in cylinder; P: bar value of the pressure sensor positioned after the HP and LP valves. Press ESC for 2 sec. to exit.

- **"Replace filter"**. Use this function when the filter need to be replaced (see routine maintenance).

- **"Recovery counter"**. This option shows the kg of refrigerant gas recovered. This is shown by the partial counter, which automatically resets after changing the filter, and the total counter, which follows the life of the unit and cannot be reset. "n" indicates the number of times the filter have been replaced. % indicates the degree of filter wear (100% end of use).

- **"Vacuum pump hours"**. This function shows the hours of operation of the vacuum pump. This is shown by the partial counter, which follows the oil changes, and the total counter, which follows the life of the unit and cannot be reset (see routine maintenance). % indicates pump oil use (100% end of use).

- **"Compressor hours"**. This function displays the hours of operation of the recovery compressor.

- **Select language**. This function is used to select one of the languages available. Use the "+ ↑" and "- ↓" buttons to move the cursor ">" to the desired language, press OK and wait 10 seconds for the new setting.

- **"Customizing"**. This function allows you to modify the values suggested in the various operations.

- Default: press OK to restore CTR's default values
- Gas quantity: Changes the value of refrigerant charge suggested in the cycles by the operator (S-Automatic + Gas Charge).
- Vacuum time. Changes the vacuum value suggested in the cycles by the operator (S-Automatic + Gas Charge).
- Cylinder full: Changes the maximum filling value desired in the "Cylinder filling" cycle.
- Garage data: enter the garage data you want to be printed on the receipt (optional printer).

Press "OK" and use the "+ ↑" and "- ↓" buttons to select the letters/numbers of the text. Press "OK" to confirm character, press "<" to move to the previous character and change it. To save the data, keep the flashing cursor at the end of the text and press "ESC".

- Print report: If the optional printer is connected, set electronic control to "YES".

6.2 Service menu for "Technical staff"



This section of the menu is reserved to technical staff authorized by CTR S.R.L.



Specialized technician: person trained and authorized by CTR S.R.L. to perform technical procedures

- **"Cylinder calibration"**. This function allows you to calibrate the gas scales.

Read the following information carefully before proceeding:



- Disconnect the unit from the mains.
- Remove the front panel.
- Remove the top panel.
- Remove the mechanical retainer of the cylinder.
- Connect the unit to the mains. Do not touch anything inside the unit unless specifically requested in this paragraph. Risk of electrocution.

	Do not discharge refrigerant into the atmosphere.
	Keep an external container to transfer refrigerant into. The container must be type-approved for pressure of at least 35 Bar and equipped with safety valve; ensure that the volume of the container is adequate to receive the content of the recovery unit.
	Do not proceed with the operation if an external container is not available!



Fig. 1



Fig. 2

- The phases of this cycle are divided into: discharge of refrigerant from cylinder, vacuum in cylinder and calibration.
- Connect the external cylinder to the service valve located in the upper part of the cylinder (Fig. 1 connection A). Open the valve of the external cylinder, rotate the valve on top of the unit's cylinder towards the outlet connector (Fig. 2 connection A), close the HP/LP valves then press "OK" to start the operation.
- Once the cycle is started, the unit will transfer all of the internal refrigerant into the external cylinder. Wait for "Cylinder calibration" message.

Press OK lightly, scrolling of the progress bar that the procedure is being performed correctly. The new message will ask you to "remove the cylinder and press OK". Loosen the two nuts that secure the cylinder to the load cell and lift the cylinder, making sure that the load cell is free from contacts, wait a few seconds then press OK to confirm. Scrolling of the progress bar indicates that the operation is being performed correctly. If the cycle has not been performed correctly it will not be possible to exit the calibration procedure, therefore it should be repeated. If the operation has been performed correctly press ESC to return to the main menu. Block the cylinder with the mechanical retainer and secure the cylinder to the scale with the nuts you previously removed.

- "**Press calibration**". This function allows you to calibrate the pressure sensor. Press OK to start the cycle. The display will read "Set atm. pressure and press OK"; remove High and Low service hoses, open the HP and LP manual valves in the front panel of the refill unit, press OK to confirm (ESC to exit). When the progress bar is complete, the new message "Close HP and LP and press OK" will be displayed; close the HP and LP manual valves in the front panel of the refill unit and press OK to continue (ESC to exit). The vacuum pump starts and when the cycle is successful completed, the message "End of cycle" will be displayed; press ESC to return to the main menu.

7. Refrigerant transfer from unit to external container

	Use an external container to transfer refrigerant into. The container must be type-approved for pressure of at least 35 Bar and equipped with safety valve; ensure that the volume of the container is adequate to receive the content of the recovery unit.
	Do not proceed with the operation if an external container is not available!

To drain the cylinder, perform the following operations:

- Switch the unit on, enter the "SERVICE" menu and perform the "Cylinder pressure >7 Bar" phase. After that, connect the HP pipe to a cylinder or another external container prepared to collect the refrigerant and open the valves on the connection line.
- Select "Charge to vehicle", set the quantity of gas you want to transfer, move the cursor to "start cycle" and press "OK".
- When transfer has been completed, close the valves and recover the residual pressure in the pipe.

8. Routine Maintenance



8.1 Refrigerant filter replacement:

This unit is equipped with an electronic system that is capable of automatically performing all the phases required for filter replacement, ensuring full safety for the operator without the help of technical staff.

When the filter counter has reached a calculated value of refrigerant recovered from vehicles, a message prompting the operator to replace the filter is displayed for a few seconds upon activation. Before proceeding, new filter must be obtained through CTR's commercial network.



- Always replace filter each time the "Replace filter" message is displayed.
- Use only dedicated original spare parts. There are no compatible filters on the market.
- The "Replace filters" message warns you when the filters need to be replaced, but does not in any way lock unit operation. If you ignore the "Replace filters" message and continue using the unit, you may irreparably compromise proper functioning of the unit and invalidate the warranty due to improper use.
- Ensure that the used oil container is empty.

- Select "SERVICE" in the main menu.
- Move the cursor to "REPLACE FILTERS".
- Close the HP and LP valves as shown on the display.
- Press the "OK" button. The electronic system activates a procedure to release pressure from the filter and, when this has been done, the message "REPLACE FILTERS" will be shown on the display. Do not switch the unit off.
- Remove the frontal panel
- Unscrews the tube connections upper and bottom (Fig. 1 e 2) using contemporary the keys Ø 11 and 14.

- Remove the bolt Ø 10 of the filter bracket (**Fig. 3**).
- Remove the exhausted filter, recovering the fittings.
- Install the new filter controlling the direction of the application (**Fig. 4**).
- Follow the reverse procedure to close the housing of the station.
- Just after closing all connections you can press "O.k." to continue the procedure.
- The Station execute in automatic the dehumidification, the leaks control, the recycle of gas in cylinder and finally resets the partial counter (recovery counter) and the service message. For every possible problem, start up the error message with block operation.
- Necessary time to complete this procedure is 20 minutes.

8.2 Replacement Vacuum pump Oil:

The life of the vacuum pump is monitored by the electronic system in order to always ensure optimal efficiency and a long life in normal operating conditions. When the service message "Change vacuum pump oil" is displayed, proceed as follows:



When topping up or changing the oil in the vacuum pump, use specific oil for vacuum pumps.
Use specific oil for high-vacuum pumps available through the commercial network of CTR S.R.L.

To fill the oil (see figure), unscrew the bleeding cap (**A**) till to halfway mark the sightglass (**C**) when is done screw the bleeding cap (**A**) back on.

To change the oil:

- run the pump for 10 minutes;
- disconnect the unit from power supply;
- loosen the 4 screws from the pump and slide on the rails (**D**)
- remove the drain plug located in the frontal part of the pump (**B**) using the allen key; wait until all of the oil has drained out; refit the drain plug.
- unscrew the bleeding cap (**A**) and pour in new oil up to the halfway mark on the sightglass; screw the bleeding cap (**A**) back on.
- repose the pump on his original position and tighten the 4 screws.

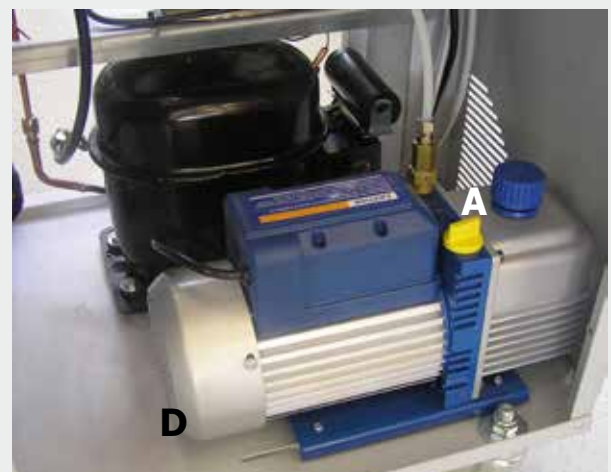

When the message "Change pump oil" is displayed, ESC and OK will appear under "Vacuum pump hours" in the SERVICE menu. After replacing the filter, press OK to reset the partial counter.



Lightning on yellow (high-voltage parts with risk of electrocution)



Instruction Booklet

KHEOS PLUS

EN

Wear safety goggles. Contact with eyes may cause serious damage to eye sight.



Operate and store the unit in a dry place protected from the weather and from direct sunlight.



Before you use the unit, read the car's operation and maintenance manual to identify the type of refrigerant.



Wear protective gloves. Contact with the skin (given the extremely low boiling temperature) may cause burns.



Mechanical cylinder retainer system.
Pressed=on
Released=off

10. SD card database update

The vehicle database resides on the removable SD card housed in the circuit board of the unit.



This operation must be carried out only by a specialized technician: person trained and authorized by CTR to perform technical procedures. Contact your local dealer

11. Printer (Optional)



Start printer through "SERVICE" menu.

- Select "Customizing", scroll to "Print Report", press "OK" with the "+ ↑ " and "- ↓ " buttons, select "YES" to start printer. To exit, press ESC for 2 sec "

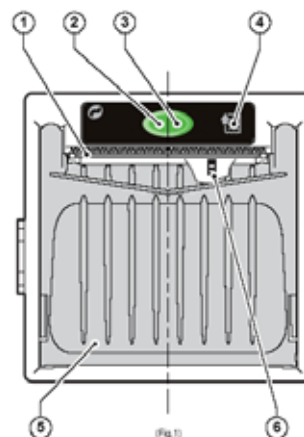
- 1 – Paper out feed slot
- 2- Status LED
- 3- OPEN button for paper roll compartment
- 4- Paper FEED button
- 5- Paper roll compartment
- 6- Out-of-paper sensor (internal)



The green status LED indicates the hardware status of the printer. In the event of malfunctioning, the LED flashing frequency will change according to the following table.

LED status	Color	Description	
	OFF	Printer off	
	ON	Printer on: no error	
	FLASHING	RECOVERABLE ERROR	
		Slow	Out of paper
		Fast	Print head overheating Incorrect supply voltage

To change the paper roll, proceed as follows:

- 1- Open the printer cover by pressing the OPEN button (see Fig.1.13).
- 2- Position the paper roll in the compartment, respecting the rotation direction indicated (see Fig.1.14).
- 3- Pull the paper until it comes out of the compartment and close the cover (see Fig.1.15). The cover locks.
- 4- Tear off the excess paper using the serrated edge (see Fig.1.16)
- 5- The printer is now ready for printing.

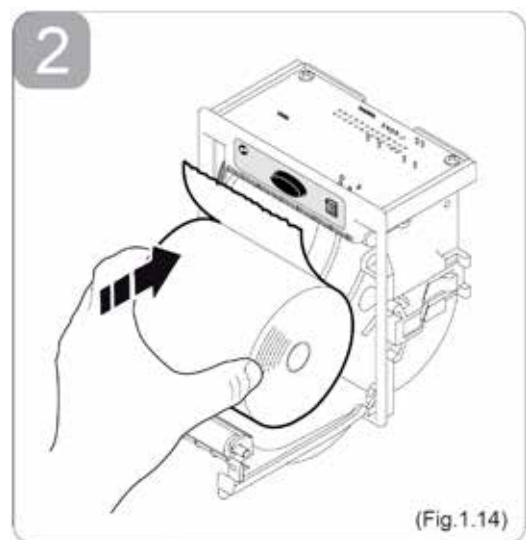
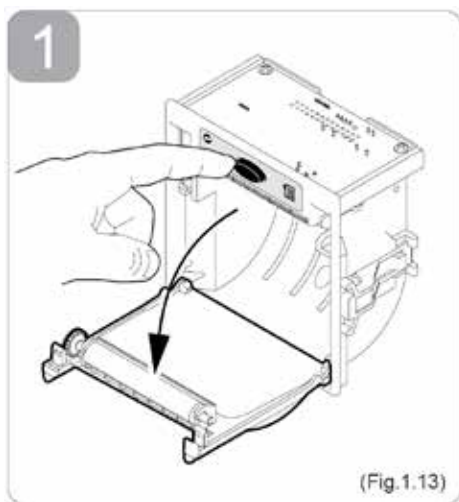

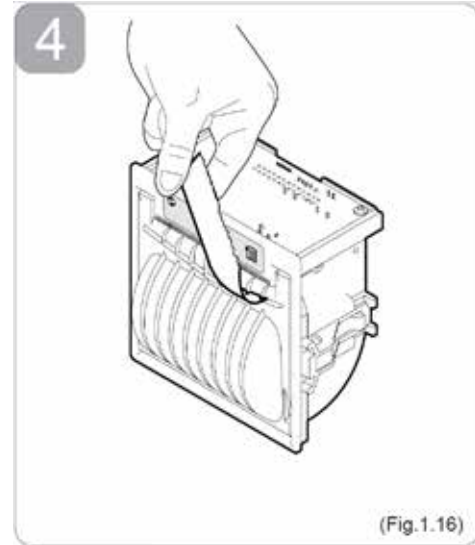
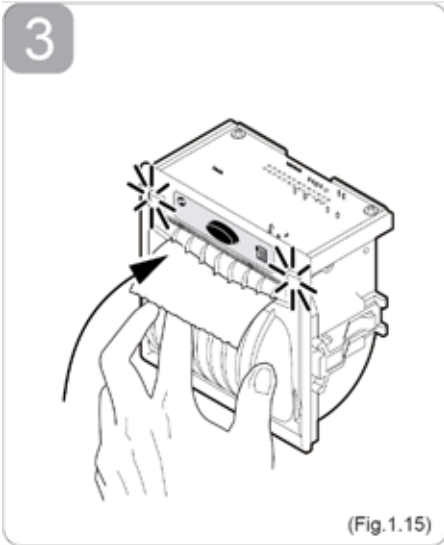

12. Troubleshooting



Repair, maintenance or adjustment operations not described in the above chapters must be performed only by specialized staff. (Failure to do so will relieve CTR S.R.L. of all responsibility for unit malfunction).



The table indicates the skill level needed to perform the operation. It is important to follow these instructions strictly.



Operator: person trained to use the machine (trained directly/indirectly by CTR staff)

Specialized technician: person trained and authorized by CTR to perform technical procedures.

After you have solved the problem with the instructions given below, you can restart the procedures you were performing from the beginning.

Problem	Causes	Remedies	Operation
Unit not working	<ol style="list-style-type: none"> Unit switched on and off repeatedly External unit fuses blown Internal unit fuses blown 	<ol style="list-style-type: none"> Switch unit off and wait at least 10 sec. before restarting unit Replace Replace 	<ol style="list-style-type: none"> Operator Operator Specialized technician
Unit not recovering	<ol style="list-style-type: none"> Fuse blown Recovery compressor damaged 	<ol style="list-style-type: none"> Check fuse in recovery compressor/solenoid valve on circuit board Replace compressor 	<ol style="list-style-type: none"> Specialized technician Specialized technician
Vacuum pump not working	<ol style="list-style-type: none"> Gas in the circuit No power to pump Vacuum pump damaged 	<ol style="list-style-type: none"> Perform a recovery phase Check power supply and fuses Replace the pump 	<ol style="list-style-type: none"> Operator Specialized technician Specialized technician

13 List of error messages

E0	Full cylinder. - Discharge cylinder gas see "Transfer refrigerant from unit to external container".
E2	Recovery time expired. - Repeat operation due to excessive quantity of refrigerant to be recovered.
E3	Refrigerant presence at beginning of vacuum phase. - Repeat recovery operation.
E4	Vacuum time expired. Vacuum timer cannot be started. - -0.75 Bar threshold cannot be reached. Check integrity of system and connection pipes.
E5	Leak presence during vacuum control. - Use leak detection system, repeat vacuum and recharge A/C system.
E6	Insufficient quantity of refrigerant in cylinder. - Fill unit with external cylinder using "Cylinder recharge operation".
E7	Refrigerant charge time expired. - Repeat recovery, vacuum and gas charge. If needed, increase cylinder pressure with "Cylinder pressure > 7 Bar" function in Service menu.
E11	There is no refrigerant to recover. - Proceed to vacuum phase.
E20	Faulty refrigerant scale. - Contact CTR's specialized technician.
E23	Faulty pressure sensor. - Contact CTR's specialized technician.

14 Fuses



