



USE, MAINTENANCE AND SPARE PARTS MANUAL



ARENA R134A

GB

**RECOVERY, RECYCLING,
VACUUM AND LOADING STATION**

1 INTRODUCTION	4
1.1 SCOPE OF THE INSTRUCTIONS MANUAL	4
1.2 HOW TO READ AND USE THE INSTRUCTIONS MANUAL	4
1.3 PRESERVING THE MANUAL	4
1.4 UPDATING THE INSTRUCTIONS MANUAL	4
1.5 INTENDED USERS	4
1.6 SYMBOLS	5
2 GENERAL INFORMATION	6
2.1 MANUFACTURER'S IDENTIFICATION DATA	6
2.2 MACHINE IDENTIFICATION DATA	6
2.3 CE PLATE	6
2.4 GENERAL SAFETY STANDARDS	7
2.5 REFRIGERANTS AND LUBRICANTS - PERSONAL PROTECTIVE EQUIPMENT AND PRECAUTIONS	8
2.6 BEHAVIOURAL STANDARDS WITH REFRIGERANT R134A	8
2.7 FIRST AID MEASURES	8
2.8 FIRE PREVENTION MEASURES	8
2.9 MEASURES IN THE EVENT OF ACCIDENTAL LEAKAGE	9
2.10 WARRANTY	9
2.11 DURATION OF THE WARRANTY	9
3 DESCRIPTION OF THE MACHINE	10
3.1 WORKING PRINCIPLE	10
3.3 TECHNICAL SPECIFICATIONS	11
4 FUNCTIONING AND USE	12
4.1 DESCRIPTION OF MACHINE FUNCTIONING	12
4.2 MACHINE CYCLES	12
4.2 PLANNED AND UNPLANNED USE	12
4.3 WORKSERVICE UNITS FOR OPERATORS	12
5 INSTALLATION	13
5.1 RECEIPT AND CONTROL	13
5.2 SERVICE UNIT START-UP	13
6 SERVICE UNIT USE	16
6.1 AUTOMATIC FUNCTIONING	16
6.2 SERVICE UNIT DATABASE	17
6.3 DATABASE USER	18
6.4 MANUAL FUNCTIONING	19
6.4.1 RECOVERY	19
6.4.2 VACUUM	20
6.4.3 OIL	20
6.4.5 GAS	21
6.5 FILTERS	22
6.7 HYBRIDS	22
6.8 SERVICE UNIT SETTINGS	23
6.8.1 DATE – LANGUAGE	23
6.9 FLOWCHART	24
6.10 ALARM MESSAGES	25
6.11 PROBLEMS AND SOLUTIONS	25
7 MAINTENANCE	26
7.1 NATURE AND FREQUENCY OF THE CHECKS AND MAINTENANCE INTERVENTION	26
7.2 EMPTYING OF USED UP OIL CONTAINER	26
7.3 PRINTER PAPER ROLL CHANGE	26
8 ADDITIONAL INSTRUCTIONS	26
8.1 PLACING OUT OF SERVICE AND DISPOSAL	26
9 SPARE PARTS	27
9.1 GENERAL PROVISIONS	27
9.2 SPARE PARTS REQUEST FORM	27
9.3 LIST OF SPARE PARTS	29
10 WIRING DIAGRAM	31
11 SERVICE PROGRAM	32

1 INTRODUCTION

1.1 SCOPE OF THE INSTRUCTIONS MANUAL

This use and maintenance manual contains the data on performance, technical characteristics and the use and maintenance methods to regulate and adjust machine functioning.

You are advised to use it carefully and comply with the standards and procedures contained in it, since it provides important instructions on safe use.

This will enable optimisation of operation, increase the duration of the machine and work in safe conditions.

Non-compliance with the standards suggested can cause malfunctions, anomalies or breakages; the machine should therefore be intended for the use for which it was expressly designed.

The **manufacturer** cannot be held in any way liable for breakages, accidents or problems arising from non-compliance (or however non-application) of the specifications contained in this manual. The same applies to implementation of changes, variants, and/or installation of accessories unauthorised in advance.

1.2 HOW TO READ AND USE THE INSTRUCTIONS MANUAL

The machine was designed in compliance with a set of EU standards regarding the free circulation of industrial products in the countries of the EU (see Machinery Directive 2006/42/EC).

The machine is therefore supplied with all the documentation required by these standards.

The use, maintenance and spare parts manual is an integral part of it and contains all the information necessary for good operation of the machine, with particular attention on responsible staff safety.

1.3 PRESERVING THE MANUAL

This booklet is an integral part of the machine, therefore it should be carefully kept for any further consultation.

- 1) You are advised to use the manual carefully to avoid damaging its content and not compromise its functionality.
- 2) Do not remove, tear or re-write the manual for any reason.
- 3) Keep the manual in a place protected from damp and heat.
- 4) The use manual must be kept near the machine for easy consultation.
- 5) The location of the manual must be clearly visible and known to all operators enabled to operate the machine.
- 6) Having terminated consultation of the manual, it must be placed back in its specific location.
- 7) The manual must be kept for the entire duration of machine use and granted to any other user or subsequent owner.

1.4 UPDATING THE INSTRUCTIONS MANUAL

The **manufacturer** reserves the right to make changes, integrations or improvements to the manual, however without reason to consider this publication inadequate.

1.5 INTENDED USERS

This documentation is addressed to qualified and adequately trained technical staff.

Only qualified staff have the necessary technical know-how to correctly interpret and apply the safety standards and warnings contained in the specific documentation.

The know-how and correct application of the safety standards and warnings are fundamental for danger-free installation and start-up, as well as safety during operation and maintenance of the product described.

"Qualified staff" is intended as those staff whose training, experience, education, as well as knowledge of the relevant standards, provisions, measures for accident prevention and service conditions, were authorised by plant safety staff to carry out all the necessary activities and as such be aware of and avoid any possible dangers.

1.6 SYMBOLS



Text in bold, preceded by this symbol, contains information or provisions which are very important for the good functioning of the machine. Non-compliance can lead to:

- loss of contractual warranty;
- non-liability of the **manufacturer**.



Text in bold, preceded by this symbol, contains compulsory provisions on the operator's behaviour to ensure safety. Non-compliance can lead to:

- risk for the operator's safety;
- non-liability of the **manufacturer**.



Text in bold preceded by this symbol contains signs of possible and important provisions to protect operator safety. Non-compliance can lead to:

- risk for the operator's safety;
- non-liability of the **manufacturer**.

2 GENERAL INFORMATION

2.1 MANUFACTURER'S IDENTIFICATION DATA

W.T.Engineering S.r.l.
 via Ugo Foscolo, 96/F 24024 Gandino (BG) – Italy
 tel. +39 035733399 - fax. +39 0357172834
info@wtengineering.it www.wtengineering.net



2.2 MACHINE IDENTIFICATION DATA

The system is manufactured in compliance with the Machinery Directive 2006/42/ currently in use in the European Community on safety. The machine has a CE marking plate and relevant product identification data attached. The serial number must also be used to request intervention or spare parts.

The identification plate and all the data it contains must always be kept legible, with periodic cleaning.

If the plate is worn and/or not legible, even if partially illegible, you are advised to request a new one from the manufacturer, stating the data contained in this manual, and replace it.

2.3 CE PLATE

 Engineering	<p>W.T. Engineering S.r.l. Via Ugo Foscolo 96/F 24024 Gandino (BG) Italy</p>	 0948
<p>Art: <input style="width: 150px; height: 20px;" type="text"/></p> <p>S/N: <input style="width: 150px; height: 20px;" type="text"/></p> <p>Year: <input style="width: 150px; height: 20px;" type="text"/></p> <p>V/Hz : <input style="width: 150px; height: 20px;" type="text"/></p> <p>Made in ITALY</p>	<p>PS(Bar):15 TS(°C):0 +40 Set Point PSV (bar) 15 Fluid GR.2 R134A</p>	

ART: Machine model

V/Hz: Machine voltage and frequency

S/N: Machine serial number

Year: Machine year of manufacture

2.4 GENERAL SAFETY STANDARDS

→ As well as the data outlined, the manager of the plant must comply with the legislation in force on staff health and safety in the workplace (Directive 2006/42/EC).

⚠ Always comply with the safety standards and instructions contained in this manual.

The **manufacturer** cannot be held in any way liable for improper use of the machine or the equipment supplied.

⚠ **The unit must not work with different refrigerant to that for which the unit was manufactured.**

⚠ The machine must be used by qualified staff and it can only be used correctly having read this manual also containing the basic safety rules provided below:

- Wear safety gloves and goggles.
- Do not expose to direct sunlight or rain.
- Only use in environments with forced ventilation that have at least an air exchange of the entire volume every 24 hours.
- Before any operation, check on the use and maintenance manual of the vehicle the type of refrigerant fluid used by the A/C system.
- Do not smoke near the machine and during operations.
- Do not use the machine in environments without lightening-proof guards.

The equipment is classified as: Group II category 3G II B T3 and must be used in places with classification 2. The environmental conditions for use of the equipment are as follows:

- pressure from 80 kPa (0.8 bar) to 110 kPa (1.1 bar);
- temperature from – 20° C to + 60° C;
- air with normal oxygen content, in general 21 % v/v.

⚠ The equipment must not be used in places at risk of explosion and/or fire classified in the following zones:

1. zone 0 – 20 / 1 – 21;
2. maximum use temperatures T4, T5 and T6.

Machine storage: the machine, when not in use, must be stored in a specific plate with the following characteristics:

1. Forced ventilation with at least one air exchange of the entire volume of the environment every 24 hours.
2. There must be no ignition sources, such as heat sources, open flames, sparks of mechanical origin, electrical material, stray electrical currents and cathodic corrosion (check the electrical distribution system complies with the standards in force); static electricity (check the grounding of the plant electrical distribution system).

- Use the machine far from heat sources, open flames and/or sparks.
- Always ensure that when you switch off the motor the ignition key of the vehicle is brought to the Fully Off (OFF) position.
- Always connect the tubing with the RED quick coupling on the high pressure branch of the A/C system.
- Always connect the tubing with the BLUE quick coupling on the low pressure branch of the A/C system.
- Keep the connection tubing far from objects or parts that are moving or rotating (cooling fan, alternator, etc.).
- Keep the connection tubing far from hot objects or parts, engine exhaust pipes, radiator, etc.).
- Always fill the A/C system with the quantity of fluid recommended by the manufacturer. Never exceed this quantity.
- Always check the oil level before each operation.
- Always top-up with the correct quantity of oil.
- Before connecting the machine to the electrical mains, check the voltage and frequency of the power mains corresponds to the values indicated on the CE plate.

The cylinder must be filled to 80% capacity maximum to leave a gas lung to absorb any pressure increases.

- Never touch the taps on the inner cylinder.
- Throw away used oil from the A/C system and the vacuum pump in the specific containers for used oil.
- Change the filters on the deadlines planned only using the filters recommended by the manufacturer.
- Only use oil recommended by the manufacturer.
- Only use tracers approved by the manufacturer.
- Never exchange the oil for the vacuum pump with oil for the conditioning systems.

Non-compliance with each of the aforementioned safety rules leads to any form of the machine warranty becoming null and void.

⚠ **ATTENTION:** the vapours/gas of refrigerant R134A are heavier than the air and can thicken on the ground or inside the cavity/pits and cause suffocation by reducing the oxygen available for breathing.

At high temperatures, the refrigerant decomposes freeing the toxic and aggressive gases, which are dangerous for the operator

and the environment. Avoid inhaling the refrigerants and oils in the system. Exposure can irritate the eyes and airways.

2.5 REFRIGERANTS AND LUBRICANTS - PERSONAL PROTECTIVE EQUIPMENT AND PRECAUTIONS

→ handle refrigerants and pressurised equipment with care, otherwise there could be a risk to health.

⚠ Do not modify calibration of the safety devices, do not remove the seals on the safety valves and the control systems. Do not use external tanks or other storage containers that are not certified or free of safety valves. During operation, the ventilation and aeration openings on the equipment must not be covered or closed.

⚠ The operator must wear adequate protection such as goggles, gloves or clothing suitable for the work, contact with the refrigerant can cause blindness (eyes) or other physical damage (freezing) of the operator. Avoid contact with the skin, the low boiling temperature (approx. -26 °C for R134A) can cause cold burns.

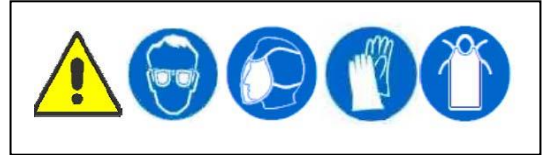

2.6 BEHAVIOURAL STANDARDS WITH REFRIGERANT R134A

The refrigerant liquids in ambient conditions are gaseous. For transport and use they must be compressed in specific cylinders. You then need to be cautious of the pressurised containers. In particular for R134A you must pay attention to the following situations: inhalation of the vapours in very high concentrations, even for short periods of time should be avoided as they can cause unconsciousness and sudden death. R134A is inflammable but if the vapour is exposed to naked flames or red hot surfaces it can undergo thermal decomposition and form acid products. The acrid and pungent odour of these decomposition products is sufficient to signal their presence. Therefore avoid finding yourself in the aforementioned conditions. There are no proven risks of absorption of R134A through the skin, however, due to the low boiling point, you are advised to wear adequate clothing to avoid sprays of liquid or vapour reaching the skin and in particular the eyes, which could cause the eye fluids to freeze. You are also advised not to dispose of refrigerant liquid R134A used in the machine because it is a substance that contributes to heating of the plant, with a global warming potential (GWP) equal to 1300.

2.7 FIRST AID MEASURES

Inhalation	Move the victim to an uncontaminated area wearing the breathing apparatus. Keep the patient lying down and warm. Call a doctor. Proceed with artificial respiration if breathing has stopped.
Contact with skin	In case of burns from freezing, spray with water for at least 15 minutes. Apply sterile gauze. Get medical help.
Contact with eyes	Immediately wash the eyes with water for at least 15 minutes
Ingestion	High unlikely method of exposure
Main symptoms and effects, both acute and delayed	In high concentration, it can cause asphyxia. The symptoms can include loss of movement and/or consciousness. The victims may not be aware they are choking. In low concentration it can have a narcotic effect. The symptoms can include dizziness, headache, sickness and loss of coordination.

2.8 FIRE PREVENTION MEASURES

Extinguishers used	All types of known extinguishers can be used.
Special danger deriving from substance or the mix	Exposure to flames can cause breakage or exposure of the container Dangerous combustion products: in the event of a fire, the following products can derive from thermal decomposition: Carbon monoxide. Hydrofluoric acid. Carbonyl fluoride

Recommendations for fire fighting operators	If possible, stop the product exiting. Coordinate fire fighting intervention based on the surrounding fire. Cool the containers exposed to risk by showering them with water jets from a safe position. Do not pour water contaminated in the fire in sewage drains.
Special protection equipment for fire fighting operators	Use a breathing apparatus in tight spaces.

2.9 MEASURES IN THE EVENT OF ACCIDENTAL LEAKAGE

Procedures in the event of an emergency	Try to stop the leak. Evacuate the area. Ensure adequate ventilation.
Personal precautions and safety devices	Use a breathing apparatus to enter the relevant zone if you have no proof the atmosphere is breathable.
Environmental precautions	Try to stop the leak. Avoid entrance in sewers, drains, pits and zones where accumulation could be dangerous.
Methods and materials for containment and clearance	Ventilate the zone.

2.10 WARRANTY

The terms and conditions of the warranty are established as follows if not otherwise specified in the order confirmation:

Warranty

The **manufacturer** guarantees the good quality and good manufacture of the machine being obliged, during the specific period of warranty, to repair or replace the parts free of charge whose breakage or early wear is due to poor quality materials used, faulty processing or imperfect assembly.

The warranty is not acknowledged in the event parts are broken or worn due to:

- Non-compliance with the instructions contained in the Use and Maintenance Manual.
- No or incorrect maintenance.
- No or incorrect cleaning of all the machine units requiring regular cleaning.
- Negligent use relating to control of the levels, filter cleaning, auxiliary services, electrical power supply.
- Use of equipment unsuitable for ordinary and extraordinary maintenance.
- Changes or tampering carried out by users or carried out by third parties, without the **manufacturer's** specific approval.
- Use of non-original spare parts.

2.11 DURATION OF THE WARRANTY

For the terms of warranty, refer to the contract.

3.3 TECHNICAL SPECIFICATIONS

Refrigerant type	R 134a
Vacuum pump capacity	2 CFM
Vacuum level	2x10 ⁻² mbar
Compressor Power	1/4 CV
Storage cylinder Refrigerant capacity	12 L.
Refrigerant scales resolution	10 g
Recovery capacity	250 g/min.
Power supply	230/50-60 Volt/Hz
Filling tubes length	180 cm
Machine dimensions	40x49x113 cm
Packaging dimensions	56x65x135 cm
Weight/Gross weight	57/62 Kg
Noise	< 70 db (A)

4 FUNCTIONING AND USE

4.1 DESCRIPTION OF MACHINE FUNCTIONING

The machine, of which the manual is part, was designed and manufactured to carry out recovery and recycling in a single series of operations, without dispersion in the environment, of refrigerant liquids in the A/C system of vehicles.

The machine also removes humidity and various deposits contained in the oil from the A/C system; thanks to its evaporator/separator it removes oil and other impurities from the A/C system, which are then transferred to a specific container. The fluid, which is perfectly recycled, is then filtrated and re-inserted in the cylinder inside the machine. This machine is capable of also conducting functionality testing and sealing of the A/C system.

4.2 MACHINE CYCLES

1) RECOVERY

- The compressor recovers the gas until the vehicle is completely empty.
- A pause of 4 minutes occurs for any melting of ice that can form inside the vehicle system; at the end of the pause, if no pressure increase occurs, work differently with gas recovery.
- Pause of 60 sec for used up oil recovery.

2) VACUUM

- High vacuum pump part.
- For cleaning of the system, you need to operate the vacuum for a sufficient time to complete drying (normally 30 min.)

3) NEW OIL RE-INTEGRATION

- New oil is placed in the system.
- Normally, at least 20g is placed inside, if however there is more recovered oil, the machine will automatically integrate the oil necessary.
- During this phase, the display indicates the quantity of oil entering the system.

4) GAS RE-CHARGING

- Gas is added to the vehicle system.
- The service unit automatically calculates the gas which can stay inside the charging tubes, therefore the exact quantity necessary for the vehicle must be set.

5) WASHING

- The operation is automatically proposed in the automatic cycle.
- It is enough to set the number of washes you want, the machine will automatically implement them and run the cycles.

4.2 PLANNED AND UNPLANNED USE

The machine in question was designed and built for use as above. The machine must not be used for uses other than those specified.

It is forbidden to:

- Use the machine with refrigerant gas other than that on the identification plate.
- Modify at any time the working principle of the machine by adding or removing parts of it.
- Use the machine in explosive environments and/or with risk of fire.
- Connect the machine to energy sources other than those planned by the manufacturer.
- Use the commercial devices for a purpose other than that planned by the manufacturer.

! **ATTENTION** The employer (or the safety manager) must ensure the machine is not used improperly, ensuring safety of the operator and the people exposed. It is compulsory for the worker to inform the employer (or the safety manager of the plant) if there is a danger of improper use of the machine, as a trained person, the employer is responsible for the intended use.

4.3 WORKSERVICE UNITS FOR OPERATORS

The machine was designed to work autonomously. The presence of an operator is only planned for connection and disconnection of the machine to the equipment, as well as the start-up cycle.

Dismantling of the safety casings and the resulting access inside the machine is only outlined for maintenance and cleaning operations.

5 INSTALLATION

5.1 RECEIPT AND CONTROL

Once the machine exits the **manufacturer's** production plant, any damage is attributable to the carrier, both via courier or the purchaser's vehicle, unless otherwise specified in the order confirmation.

If in doubt, please inform the **manufacturer** as soon as possible.

At the time of delivery, it is therefore necessary to control:

- Correspondence between the Delivery Docket (Packing List) and the actual content of the packaging.
- The integrity of the packaging in all its parts, to identify any obvious damage attributable to the carrier.
- Any damage on the machine following wrong transport attributable to the carrier.

Content of the packaging:

- 1 unit to process refrigerants
- 1 blue tube for low pressure L=300cm
- 1 red tube for high pressure L=300cm
- 1 blue tube for quick coupling for low pressure
- 1 red tap for quick coupling for high pressure
- 1 power supply cable

5.2 SERVICE UNIT START-UP

The machine is supplied completely assembled and inspected. Before use, proceed to prepare the service unit:

1) Refrigerant scales release

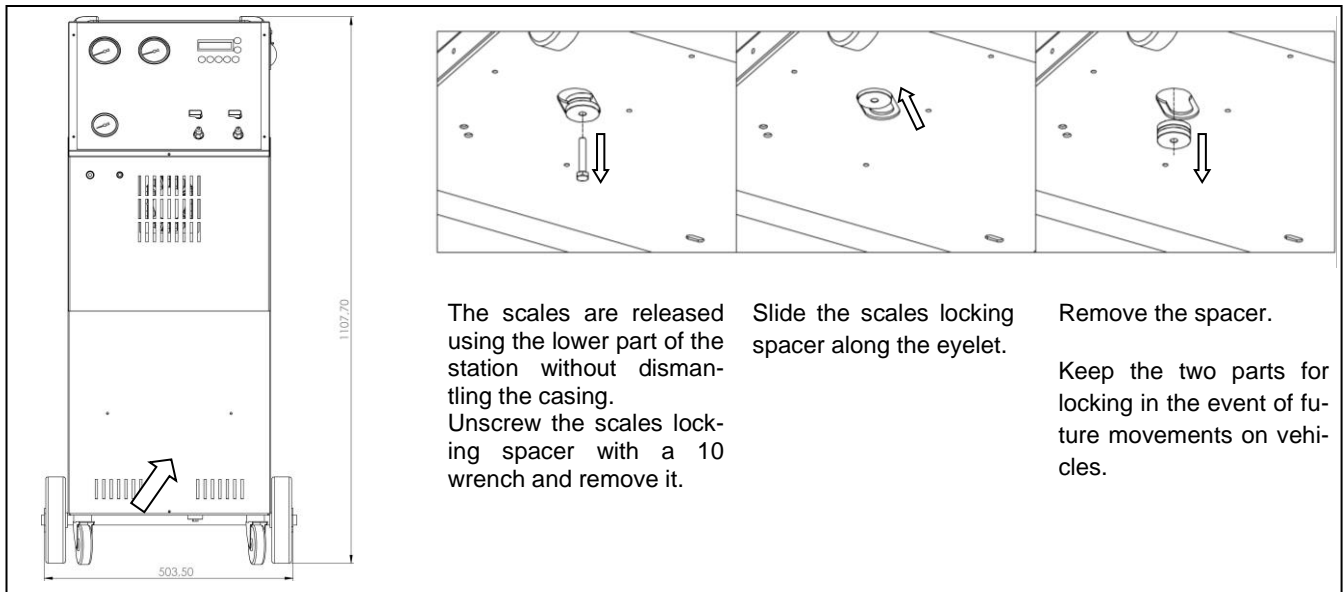

The scales are released using the lower part of the station without dismantling the casing. Unscrew the scales locking spacer with a 10 wrench and remove it.

Slide the scales locking spacer along the eyelet.

Remove the spacer.

Keep the two parts for locking in the event of future movements on vehicles.

! To avoid irreparable damage on the scales it is compulsory to block it again in the event the machine has to be transported on vehicles.

To proceed to blocking the scales, you need to implement the following operations.

- Insert the scales locking space in the eyelet.
- Tighten the screw on the spacer of the scales lock.

- Using the ↓ button, move the cursor on the MENU then CYLINDER and then press OK.

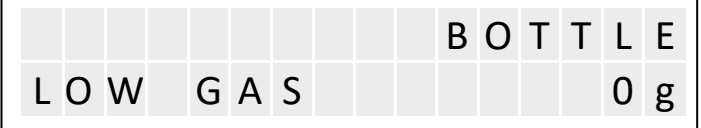
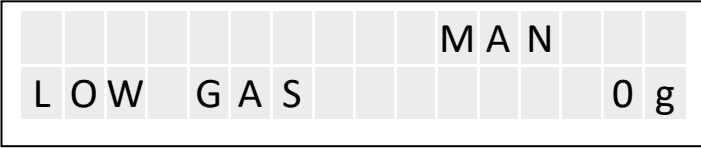

-Enter the quantity of gas you want to put in the service unit through the ↓ and ↑ arrows.

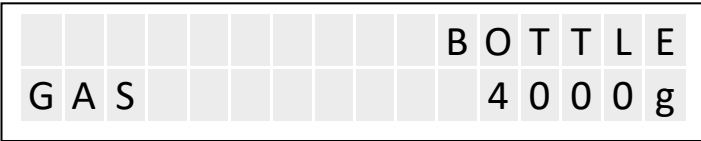

- Open the high pressure tap on the command panel and confirm with OK.
- In the recovery phase, the display shows the weight of the gas that you are inserting.
- On reaching 500g. from the quantity set, the service unit stops and the display shows " CLOSE CYLINDER".
- Close the taps on the outer cylinders and confirm with OK, wait for the service unit to automatically end its cycle.

The machine is equipped with a device that checks the pressure of the loading container; during the recovery phase, it can happen that the maximum threshold is exceeded, then the machine stops automatically indicating "High pressure alarm" on the display. In this case, you need to wait for the pressure to go down by itself.

6 SERVICE UNIT USE

6.1 AUTOMATIC FUNCTIONING

Following the start-up operations, the service unit is ready to perform its function.

- Connect the system, with the taps closed, to the vehicle using the flexible tubes supplied.
- Connect the BLUE tube to the low pressure circuit and the RED tube to the high pressure circuit, open the taps on the tubes and on the service unit.
- Switch on the service unit and wait for the main page to be displayed:

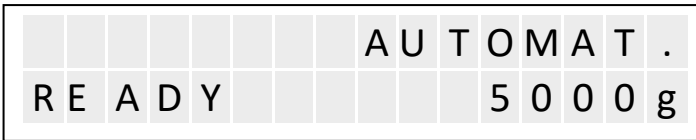

Press the OK button proceed with the automatic cycle.

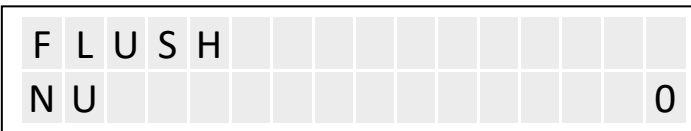

The standard parameters can be modified with the arrows confirmed with OK.

- WASHING =** WASHING CYCLE NUMBER TO RUN
- VACUUM =** VACUUM TIME
- OIL=** QUANTITY OF OIL TO ADD TO THE CIRCUIT

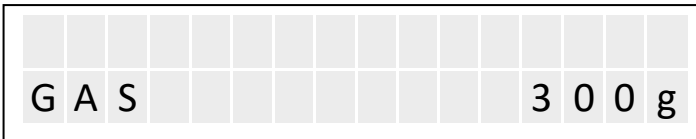

- GAS=** QUANTITY OF GAS TO ENTER IN THE CIRCUIT (The exact quantity is outlined in the plate inside the engine compartment). Selection of the quantity in manual mode or using DataBase (see par. 6.2)
- START=** START PROCEDURE
Press START to begin.

6.2 SERVICE UNIT DATABASE

The service unit is equipped with an advanced database:

To access, simply press the DB key on the command panel keyboard, on request of the quantity of gas.

A	L	F	A		R	O	M	E	O											

The upper part of the display will indicate the brand of vehicle, select the desired one using the arrows and confirm with OK.

A	L	F	A		R	O	M	E	O											1
1	4	7																		0 1 / 1 4

Under the brand of vehicle the model of the vehicle and the manufacturing period will appear. Select the one desired using the ↓ and ↑ arrows, check the corresponding quantity of gas and confirm with OK.

6.3 DATABASE USER

NOT EXPECTED

6.4.2 VACUUM

This function allows the service unit to create the vacuum in the A/C system of the vehicle.

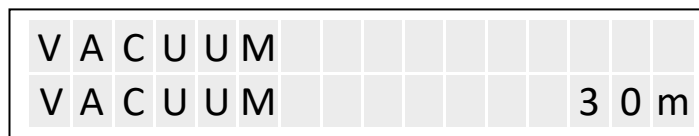

The default time is set at 30 minutes, to modify it use the ↓ and ↑arrows.

Press OK to start the vacuum cycle.

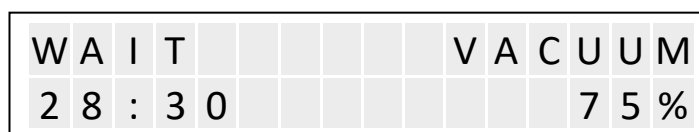

The service unit during the cycle indicates the vacuum percentage of the A/C system and the remaining time for the end of operation.

At the end of the cycle, the service unit will carry out a diagnosis of the vacuum lasting 3 minutes.

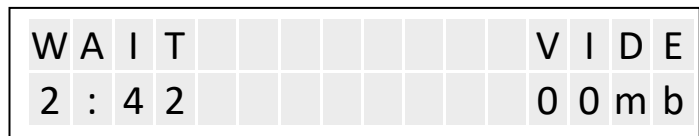

6.4.3 OIL

This function will manually top-up the oil in the A/C system in the vehicle.

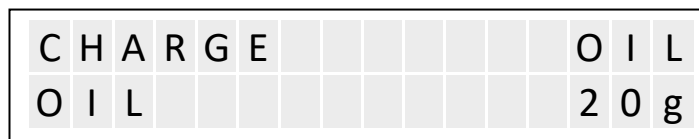

The default quantity is 20 grams, to change it use ↓ and ↑arrows to select.

Press OK to start the oil filling cycle.

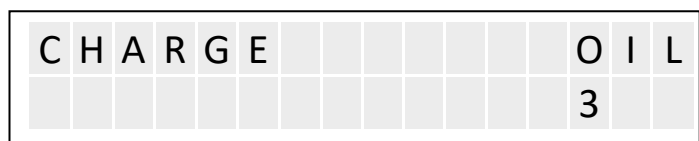

During the filling phase, the display shows the oil in grams to fill and those actually filled.

6.4.5 GAS

This function will manually charge the gas in the A/C system in the vehicle.

C	H	A	R	G	E																G	A	S		
G	A	S																				3	0	0	g

Add the desired quantity of gas (check the plate on the motor compartment) through ↓ and ↑ arrows.

C	H	A	R	G	E																			G	A	S		
G	A	S																							5	0	0	g

Press OK to start charging the gas. The display shows the quantity of gas transferred in the system.

C	H	A	R	G	E																						G	A	S
G	A	S																									3	0	g

6.5 FILTERS

This function allows you to empty the filters in the service unit and then proceed to replacement. Select MENU then FILTERS to start the function.

G	A	S										R	E	C	O	V	E	R
1	0	g										8	0	0	m	b		

At the end of the operation, replace the filters pos. F0464.

6.7 HYBRIDS

This function prepares the service unit for use with hybrid vehicles:

H	Y	B	R	I	D													
W	A	I	T									9	0	0	m	b		

H	Y	B	R	I	D													
W	A	I	T							-	0	:	5	0				

6.8 SERVICE UNIT SETTINGS

Press the setup/DB button you access the service unit settings section:

P	A	S	S	W	O	R	D	_												

Based on the type of password you enter we have access to a determined section of settings:

- 0000:** DATE – LANGUAGE
- 2214:** HEADING - OPERATOR

6.8.1 DATE – LANGUAGE

This section allows you to set the data and time of the service unit and the language to use. Select the item you intend changing with the ↓ and ↑ arrows and press OK.

P	A	S	S	W	O	R	D													0	0	0	0
L	A	N	G	U	A	G	E																

6.9 FLOWCHART

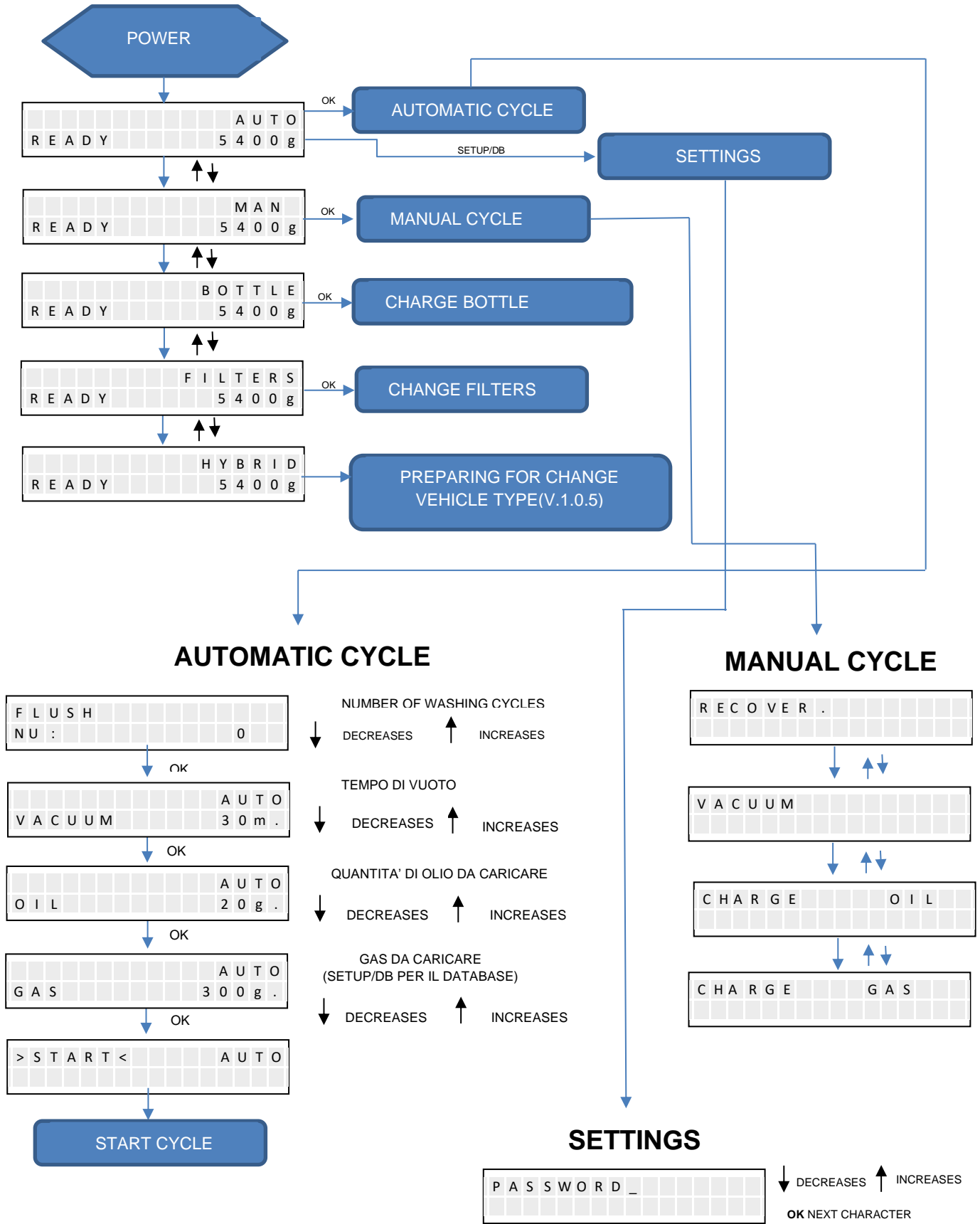

6.10 ALARM MESSAGES

During functioning, some alarm messages appear on the display:

ALARM	CAUSE - RESOLUTION
LEAK	The A/C system of the vehicle is leaking.
FULL CYLINDER	The gas container has reached the maximum level
HIGH PRESSURE	The container has reached the maximum permitted level
LITTLE GAS	The container does not have enough gas to guarantee regular re-charge (min. 2 kg.)
MEM FULL	The memory of the cycles is full and must be deleted
SERVICE	The service unit requires maintenance. Contact the technical service.

6.11 PROBLEMS AND SOLUTIONS

The search for faults and any repair intervention requires respect for ALL THE SAFETY PRECAUTIONS indicated in chapter 2.

PROBLEM	SOLUTION
General problems	
The machine is not working, the main switch does not switch on	Check the line fuse (assembled on the input socket)
	Check the power supply cable
	Replace the white switch
On switch on, only the white switch turns on, the display stays off	Replace the white switch
	Replace the display board *
	Replace the CPU board *
The machine works, but does not accept any command from the keyboard	Replace the display board *
	Replace the display connection cable *
	Replace the CPU board *
Weighing problems	
On switch on, the weight of the gas is not indicated even if present	Check the gas scale is not blocked
	Replace the CPU board *
During recovery, the weight of the recovered gas is not indicated	Check the gas scales is not blocked
	Check tap opening
Display problems	
The display shows incomplete figures	Replace the display board *
Functional problems	
On start-up, recovery is skipped and immediately goes to the vacuum phase	Replace the CPU board *
Recovery starts, but the gas is not recovered	Replace the CPU board *
	Replace the relay board *
	Check tap opening
	Check the INPUT solenoid valve *
The re-integration phase adds much more oil than that set	Replace the compressor *
	Check the oil scales is not blocked
The vacuum phase does not implement negative pressure	Replace the RE-INTEGRATE solenoid valve *
	Replace the CPU board *
	Replace the relay board *
	Replace the vacuum pump *
The heating resistor is not working	Replace the VACUUM solenoid valve *
	Replace the heating resistor

* CONTACT THE MANUFACTURER'S SUPPORT SERVICE.

7 MAINTENANCE

! ALL THE MAINTENANCE OPERATIONS MUST BE IMPLEMENTED WITH THE MACHINE STOPPED.

7.1 NATURE AND FREQUENCY OF THE CHECKS AND MAINTENANCE INTERVENTION

To keep the unit fully efficient, you need to comply with the maintenance times indicated.

! NON-COMPLIANCE WITH THE ABOVE EXONERATES THE MANUFACTURER FROM ANY LIABILITY IN TERMS OF WARRANTY.

AFTER 1 WEEK of start-up, check:

- Screws are correctly tightened;
- Tubes are correctly tightened;
- The oil level in the pump.

EVERY 6 MONTHS OR SERVICE INDICATION check:

- Screws are correctly tightened;
- Tubes are correctly tightened;
- The integrity of the connection tubes;
- The oil level in the pump;
- Replace the dehydrated filters;
- Check the scales calibration;
- Check the leaks.

→ **ATTENTION!** The lubricant must not be dispersed in the environment; it is special waste and as such must be disposed of according to standards in force.

→ **ATTENTION!** The filter must not be dispersed in the environment; it is special waste and as such must be disposed of according to standards in force.

7.2 EMPTYING OF USED UP OIL CONTAINER

When the oil level exceeds 200 ml you need to empty the container of used up oil. Disconnect the used oil container carefully without pressurising the scales. Unscrew the container, keeping the tap fixed and emptying it in a used up oil tank. Re-start the container, always keeping the plug fixed and re-inserting it in its compartment carefully without pressing on the scales. **N.B.** To avoid damaging the oil scales, never press on it upwards or downwards.

7.3 PRINTER PAPER ROLL CHANGE

Use thermal paper with the following specifications:

Paper width 58 mm

Maximum diameter of the roll of paper 50mm

8 ADDITIONAL INSTRUCTIONS

8.1 PLACING OUT OF SERVICE AND DISPOSAL

Based on the Directive 2012/19/EU, the machine cannot be disposed of as urban waste, however it is compulsory to deliver it to a specialist centre for the separate collection and disposal of WEEE waste (Waste of Electrical and Electronic Equipment), or can be redelivered to the vendor if a new one is purchased. The law foresees sanctions for anyone dumping WEEE in the environment. WEEE if dumped in the environment or used improperly, can release dangerous substances for the environment and human health.

8.2 BATTERY DISPOSAL

The machine uses an electronic data sheet with a Nickel Metal-Hydrate (NiMH) battery inside, therefore at the end of its life must be removed by expert staff responsible for demolition of the machine.

9 SPARE PARTS

9.1 GENERAL PROVISIONS

Only use **ORIGINAL SPARE PARTS** when replacing spare parts.

The use of non-original spare parts leads to immediate suspension of the warranty. The **manufacturer** cannot be held in any way liable for safety of the machine in the event of accidents.

The **manufacturer** makes available to the client and in its plant, its technicians to solve the problem of using and maintaining the machine.

To order a spare part, you need to use the form attached below that must be fully compiled.

A list follows specifying, for the individual pieces, the number corresponding to the position occupied in the drawings attached, the code and the description.

The orders (which must be sent via fax or via e-mail) must be addressed to:

Cooling Edge Ltd

Unit 9 Stanley Court
Edison Close, Telford Way
Waterwells Business Park
Quedgeley, Gloucester
GL2 2AE

Email : sales@coolingedge.co.uk

Phone No : 01452 855552

Fax No : 01452 757022

9.2 SPARE PARTS REQUEST FORM

The following page outlines the form to use to order spare parts.

If spare parts are required or to request a quote for spare parts, you are advised to photocopy the form and fill out each part.

A form filled out in detail will ensure a fast response by the **manufacturer's** technical support centre.

9.3 LIST OF SPARE PARTS

CODE		DESCRIPTION
F0008		Quick coupling R134 blue
F0009		Quick coupling R134 red
F0010		Flex Hose H-DA Red L=1800
F0011		Flex Hose H-DA Blue L=1800
F0094		Main switch
F0254	*	Gas charging cell 12 L.
F0327		Safety valve 15 bar
F0342		Liquid container 12 L.
F0343		Low Pressure Gauche D=63 R134
F0344		High Pressure Gauche D=63 R134
F0351	*	PVC flask 250ml+plug
F0353	*	Flanged solenoid valve+sol
F0464	*	Dehydrator filter 082
F0534		Cylinder gauge D=50
F0552		Wheel D=80 with brake
F0580	*	Display Board
F0581	*	CPU Card
F0582	*	Relay Card
F0584		Filter

CODE		DESCRIPTION
F0587		Radiator
F0589		Evaporator-Separator
F0590		Wheel D0175
F0706		Fan 120X120
F0708		NR Valve
F0722	*	Pressure transducer
F0746		Evaporator seal ring
F0748		NGI safety valve 15 bar
F0750		Vacuum pump VE115
F0751		Compressor EMT6160
F0752		178MM handle
F0753		Keyboard Label
F0754		Taps label

* RECOMMENDED SPARE PARTS

TABLE 1

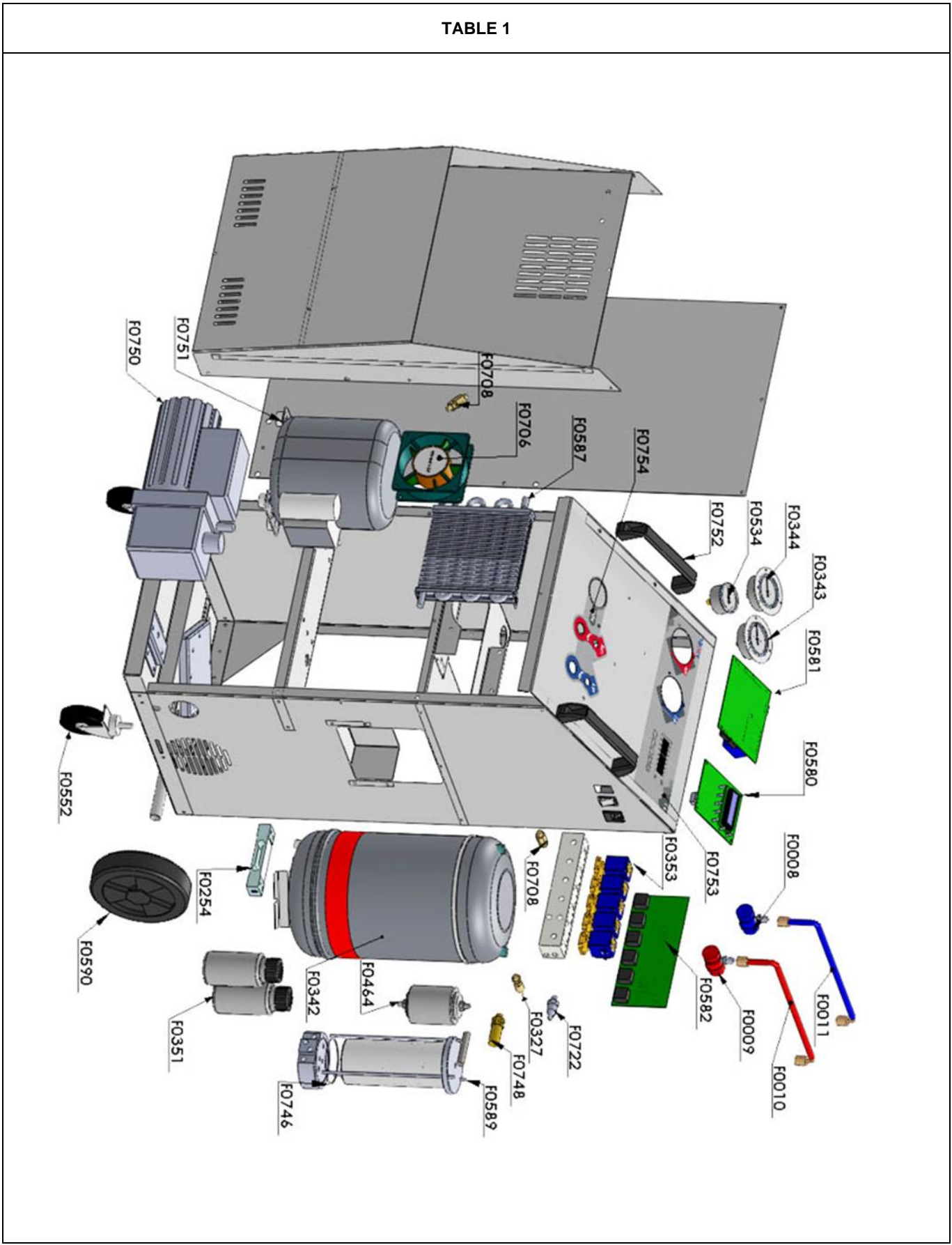

10 WIRING DIAGRAM

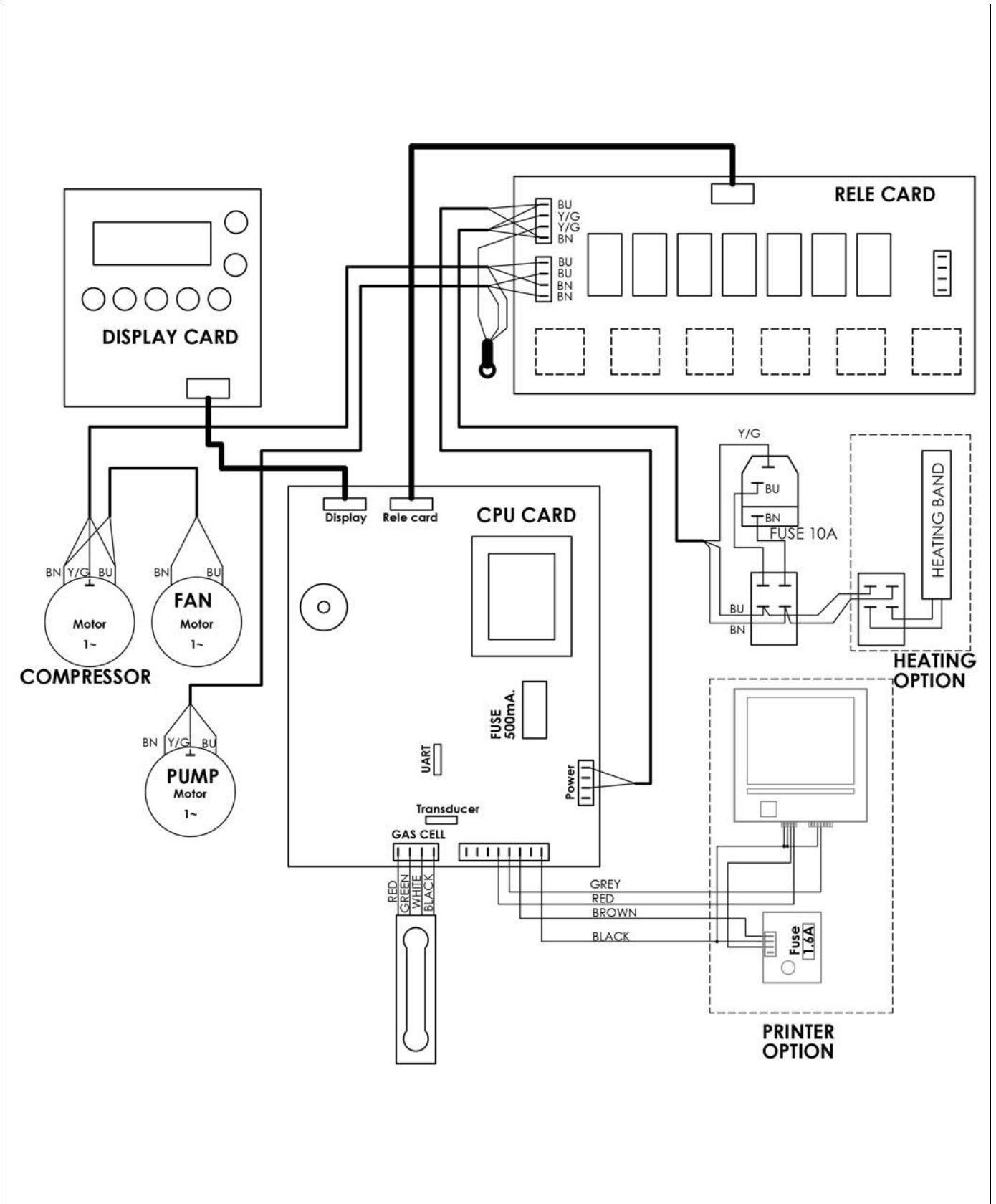



11 SERVICE PROGRAM

DATE : NU. CYCLES:.....

Done works

Replacing oil pump Replacement filters Overall control

Other:
.....

DATE : NU. CYCLES:.....

Done works

Replacing oil pump Replacement filters Overall control

Other:
.....

DATE : NU. CYCLES:.....

Done works

Replacing oil pump Replacement filters Overall control

Other:
.....

DATE : NU. CYCLES:.....

Done works

Replacing oil pump Replacement filters Overall control

Other:
.....

DATE : NU. CYCLES:.....

Done works

Replacing oil pump Replacement filters Overall control

Other:
.....



W.T.Engineering s.r.l.

Via Ugo Foscolo 96/F
24024 Gandino (BG)
Italy

Dichiarazione di conformità UE/Declaration of Conformity (DoC) Déclaration de conformité UE/ EU-Konformitätserklärung

Nome del fabbricante/Company name/ Nom du fabricant/ Name des Herstellers: **W.T.Engineering S.r.l.**
Indirizzo postale / Postal address/ Adresse postale / Postanschrift **Via Ugo Foscolo 96/F**
CAP e Città / Postcode and City/ Code postal et ville/Postleitzahl und Stadt: **24024 Gandino (BG)**
Telefono / Telephone/ Téléphone/Telefon : **+39 035 733399**
Indirizzo Posta elettronica / E-Mail address/ Adresse e-mai/E-Mail-Adresse I: info@wtengineering.it

La presente dichiarazione di conformità è rilasciata sotto la responsabilità esclusiva del fabbricante
This declaration of conformity is issued under the sole responsibility of the manufacturer
Cette déclaration de conformité est émise sous la seule responsabilité du fabricant
Diese Konformitätserklärung wird in der alleinigen Verantwortung des Herstellers ausgestellt

Apparecchio modello / Apparatus model/
Maquette d'appareil / Gerätemodell:

**SIMAL 134 - SIMAL 1234 - ARERA 134 - ARERA 1234
GREEN 134 - GREEN 1234 - A/C BUS - A/C BUS 1234**

Tipo prodotto / Product Type: **Stazione di ricarica impianti A/C / Charging station systems A / C**
Type de produit/ Produkttyp: **Systèmes de station de charge A / C / Ladestationssysteme A / C.**

Numero serie / Serial number/ Numéro de série/Seriennummer:

Procedura di conformità utilizzata per l'insieme/ Compliance procedure used for the set:
Procédure de conformité utilisée pour l'ensemble/Konformitätsverfahren für das Set

B+C2

Procedura di conformità utilizzata per la bombola / Compliance procedure used for the tank:
Procédure de conformité utilisée pour le réservoir/Konformitätsverfahren für den Tank

B+C2

Procedura di conformità utilizzata per la valvola di sicurezza / Compliance procedure used for the safety valve:
Procédure de conformité utilisée pour la soupape de sécurité/Konformitätsverfahren für das Sicherheitsventil

H1

L'oggetto della dichiarazione di cui sopra è conforme alla normativa di armonizzazione dell'Unione:

The object of the declaration described above is in conformity with the relevant Union harmonisation legislation:

L'objet de la déclaration ci-dessus est conforme à la législation d'harmonisation de l'Union:

Der Gegenstand der obigen Erklärung entspricht den Harmonisierungsvorschriften der Union:

2006/42/CE -- 2014/68/UE - 2014/30/UE - 2014/35/UE

Riferimento alle pertinenti norme armonizzate utilizzate / The following harmonised standards and technical specifications:

Référence aux normes harmonisées pertinentes utilisées/ Verweis auf die einschlägigen harmonisierten Normen

EN ISO 4126:2019 - EN 13136:2019 - EN 61000-6-1:2007-01 - EN 61000-6-3:2007-11

EN 61000-6-3/A1:2013-06

Organismo notificato / Notified body/ Organisme notifié:

Nome / Company name: **TUV SUD** NU.: **0948** NU.certificati: **TIS-PED-MI-20-07-279004-16209**
TIS-PED-MI-20-07-279004-16210

Gandino: 10/01/2022

LEGALE RAPPRESENTANTE
(Claudio Peroni)



Cooling Edge Ltd

Unit 9 Stanley Court Edison Close, Telford Way
Waterwells Business Park
Quedgeley, Gloucester
GL2 2AE

Email : sales@coolingedge.co.uk

Phone No : 01452 855552 Fax No : 01452 757022